

# CYRUS

ENGINEERED TO ENTERTAIN



---

**CONTENTS**

---

IMPORTANT! READ BEFORE OPERATING THIS EQUIPMENT! ..	1	OPERATION .....	12
Power supply: .....	2	Key to the front panel drawing: .....	12
Servicing: .....	2	Power .....	12
Product service centres: .....	2	Selecting an Input .....	12
FCC NOTICE .....	3	Selecting the 'Cyrus AV' or 'AV Direct' Inputs .....	12
WELCOME TO THE WORLD OF CYRUS! .....	4	Volume and Balance .....	13
Preparations for Installation .....	4	Mute .....	13
INSTALLATION .....	5	Listening to headphones .....	13
Key to the rear panel drawing:.....	5	Playing music in Zone 2 .....	13
Connecting to the AC Mains Supply .....	6	Tape/Disc Playback and Recording .....	14
Important – read before making any audio connections.....	6	REMOTE CONTROL OPERATION .....	15
Connecting Analogue Audio Sources.....	6	Remote control introduction: .....	15
Connecting a Turntable.....	6	Remote control backlight:.....	15
Digital Audio Inputs .....	6	Fitting batteries to the remote control: .....	15
Connecting digital audio sources .....	6	Sending commands to Cyrus components:.....	15
Connecting USB audio sources .....	6	Switching on Cyrus components:.....	15
Connecting a Power Amplifier/Speakers .....	7	Cyrus amplifier commands .....	16
Using the Zone 2 output .....	7	Cyrus CD player commands .....	17
Setting up Zone 2 with powered speakers .....	7	Cyrus Audio streamer commands.....	18
Setting up Zone 2 with a second amplifier.....	7	Learning TV and Satellite commands.....	19
Connecting a Tape/Disc recorder for recording .....	7	Preparation for learning:.....	19
Bi-amping.....	8	Learning commands:.....	19
Connecting power amplifiers: .....	8	Checking programmed commands:.....	20
Connecting Headphones .....	8	Problems with learning:.....	20
Connecting a Cyrus Surround Sound decoder .....	8	Sending TV or SAT commands .....	20
Connecting a Surround Sound decoder (other brand) .....	8	TROUBLESHOOTING GUIDE.....	21
MC-BUS System .....	9	SPECIFICATIONS.....	22
External Power Supply - PSX-R .....	9	Power Supply .....	22
CONFIGURATION .....	10	Power Consumption .....	22
Input names .....	10	Enclosure .....	22
Input 11 auto-hide .....	10	Analogue audio performance .....	22
Display mode .....	11	Digital audio performance .....	22
Input sensitivity offset .....	11	WARRANTY.....	22
Factory Settings .....	11	WEEE.....	22

---

**IMPORTANT! READ BEFORE OPERATING THIS EQUIPMENT!**

**CAUTION:** The exclamation mark is to draw your attention to important instructions and safety procedures in this manual.



**ATTENTION:** The lightning flash warns you of the risk of electrical shock presented by components inside this product. Unauthorised personnel must not open this unit.



**WARNING:** To reduce the risk of electrical shock do not remove any unit covers or panels. There are no user serviceable parts in this product.

**WARNING:** To reduce the risk of electric shock, do not expose this equipment to rain or moisture.

**HEED WARNINGS:** All warnings on the product and in the operating instructions should be adhered to.

**READ ALL THE INSTRUCTIONS:** All the safety and operating instructions should be read before the product is operated.

**RETAIN INSTRUCTIONS:** The safety and operating instructions should be retained for future reference.

**FOLLOW INSTRUCTIONS:** All operating and use instructions should be followed.

**CLEANING:** Unplug this product from the mains before cleaning. Do not use liquid or aerosol cleaners. Use a damp cloth for cleaning.

**WATER AND MOISTURE:** Do not use this product near water - for example, near a bath tub, wash bowl, kitchen sink, or laundry tub, in a wet basement; or near a swimming pool and the like. The product must not be exposed to dripping or splashing and no objects filled with liquids, such as vases, shall be placed on the product.

**HEAT:** The product should be situated away from heat sources such as radiators, stoves, or any other products (including amplifiers) that produce heat.

**VENTILATION:** Slots and openings in the cabinet are provided for ventilation, to ensure reliable operation of the product and to protect it from overheating and these openings must not be blocked or covered. The openings should never be blocked by placing the product on a bed, sofa, rug or similar surface. This product should not be placed in a built-in installation such as a bookcase or rack unless proper ventilation is provided or the manufacturer's instructions have been adhered to.

**OBJECT OR LIQUID ENTRY:** Never push objects of any kind into this product through openings as they may touch dangerous voltage points or short-out parts that could result in a fire or electric shock.

**ACCESSORIES:** Do not place this product on an unstable cart, stand, tripod, bracket, or table. The product may fall, causing serious injury to a child or adult, and serious damage to the product. Use only with a cart, stand, tripod, bracket or table recommended by the manufacturer, or sold with the product. Any mounting of the product should follow the manufacturer's instructions, and should use a mounting accessory recommended by the manufacturer.

**ATTACHMENTS:** Do not use attachments not recommended by the product manufacturer as they may cause hazards.

**MOVING THE PRODUCT:** A product and cart combination should be moved with care. Sudden stops, excessive force, and uneven surfaces may cause the product and cart to overturn.



**POWER SOURCES:** This product should be operated only from the type of power source indicated on the marking label. If you are not sure of the type of power supply to your home, consult your product dealer or local power company. For products intended to operate from battery power, or other sources, refer to the operating instructions.

**OVERLOADING:** Never overload wall outlets, extension cords, or integral convenience receptacles. This can result in an increased risk of fire or electric shock.

**POWER CORD PROTECTION:** Power supply cords should be routed so that they are not likely to be walked on or pinched by items placed upon or against them, paying particular attention to cords at plugs, convenience receptacles, and the point where they exit from the product.

**NAKED FLAMES:** No naked flame sources, such as candles, must be placed on this product.

**LIGHTNING:** For added protection for this product during a lightning storm, or when it is left unattended or unused for long periods of time, unplug it from the wall outlet and disconnect the antenna or cable system. This will prevent damage to the product due to lightning and power-line surges.

**BATTERIES:** Warning : Batteries shall not be exposed to excessive heat such as sunshine, fire or the like.

**CAUTION! POLARISED CONNECTOR (CANADA and USA):**

To prevent electrical shock, match wide blade of plug to wide slot, fully insert. Do not alter or remove this plug if it does not fit your mains power socket. Have a suitable socket installed by a competent electrician.

**ACCESS TO THE MAINS PLUG:** The means to disconnect this product from the mains supply is the mains plug. Ensure that the mains plug is accessible at all times.

**Power supply:**

Connect the moulded IEC connector of the AC cord supplied plugs into the power inlet  on the rear of the unit.

The mains supply requirement of your amplifier is marked on a label on the rear panel. Before connecting, check that this voltage is the same as your mains supply.

230V Products: Voltage Range 220V-240V

115V Products: Voltage Range 110V-120V

If you move to an area with a different mains voltage, contact your local Cyrus distributor to have your product converted.

There are no user replaceable fuses in this unit.

**Servicing:**

Do not attempt to service this product yourself as opening or removing covers may expose you to dangerous voltage or other hazards. Refer all servicing to qualified service personnel.

**CONDITIONS REQUIRING SERVICE:** Unplug this product from the wall outlet and refer servicing to qualified service personnel when:

- When the power supply cord or plug is damaged.
- If liquid has been spilled, or objects have fallen into the product.
- If the product has been exposed to rain or water.
- If the product has been dropped or damaged in any way.
- If the product does not operate normally by following the operating instructions. (Adjust only those controls that are covered by the operating instructions. Improper adjustment of other controls may result in damage requiring extensive work by a qualified technician to restore the product to its normal operation).
- When the product exhibits a distinct change in performance.

**REPLACEMENT PARTS:** When replacement parts are required, be sure the service technician has used replacements specified by the manufacturer or have the same characteristics as the original part. Unauthorised substitutions may result in fire, electric shock, or other hazards.

**SAFETY CHECK:** Upon completion of any service or repairs to this product, ask the service technician to perform safety checks to determine that the product is in proper operating condition.

**Product service centres:**

For product service or technical advice, contact only authorised Cyrus service centres. Contact details for Cyrus distributors may be found on the Cyrus website at [www.cyrusaudio.com](http://www.cyrusaudio.com).

**FCC NOTICE\***

NOTE: This equipment has been tested and found to comply with the limits for a Class B digital device, pursuant to Part 15 of the FCC rules. These limits are designed to provide reasonable protection against harmful interference in a residential installation. This equipment generates, uses and can radiate radio frequency energy and, if not installed and used in accordance with the instructions, may cause harmful interference to radio communications. However, there is no guarantee that interference will not occur in a particular installation. If this equipment does cause harmful interference to radio or television reception, which can be determined by turning the equipment off and on, the user is encouraged to try and correct the interference by one or more of the following measures:

- Reorient or relocate the receiving antenna.
- Increase the separation between the equipment and receiver.
- Connect the equipment into an outlet on a circuit different from that to which the receiver is connected.
- Consult the dealer or an experienced radio/TV technician for help.

Any changes or modifications not expressly approved by the manufacturer could void the user's authority to operate the equipment.

\*115V products

**WELCOME TO THE WORLD OF CYRUS!**

Congratulations on your choice of Cyrus Hi-fi products. Our state-of-the-art design technology and outstanding quality of manufacture has won countless awards around the world. We are confident that you will derive great pleasure from owning a product from one of the most recognised and respected manufacturers of hi-fi equipment.

Now is a good time to register your new Cyrus product. Registration takes only a few minutes, brings the added benefit of a full two year factory warranty and adds you to our mailing list for future product updates and upgrades. To register, visit [www.cyrusaudio.com](http://www.cyrusaudio.com) and click the 'Login/Register' link.

Please read these instructions carefully before commencing installation. They provide full guidance to help you install your amplifier safely and correctly.

**Preparations for Installation**

Before installing your Cyrus amplifier check that the following items are included in the accessory box.

- Power Cable
- Remote Handset
- 2 cables for MC-BUS connection

After removing these items, please retain the packaging.

Install the amplifier in a well ventilated location away from sources of high temperature, dust or humidity. Never stand the amplifier under another unit or on any surface likely to obstruct its cooling or ventilation.

## INSTALLATION

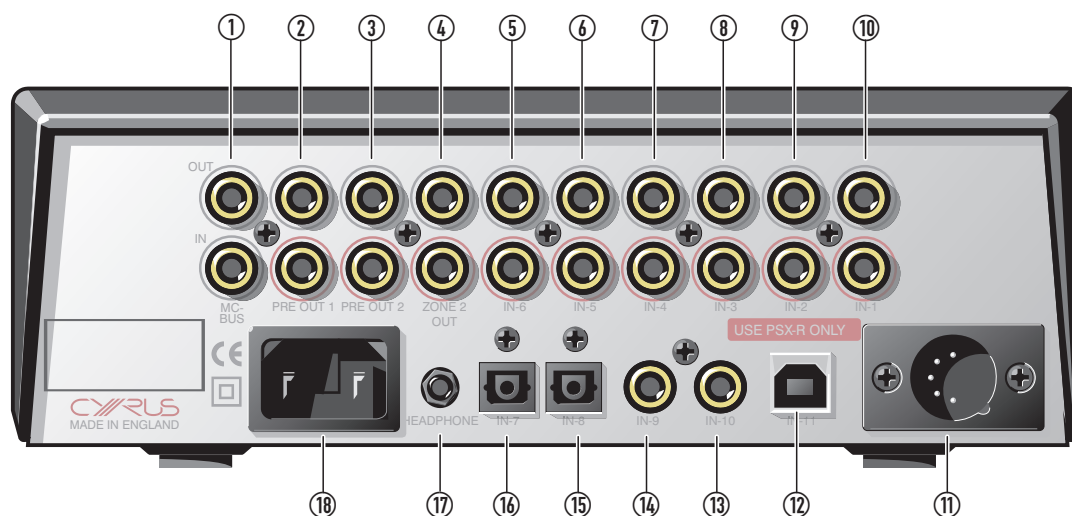

### Key to the rear panel drawing:

- |                             |                             |                      |
|-----------------------------|-----------------------------|----------------------|
| 1. MC-BUS system connection | 7. Analogue input 4         | 13. Digital input 10 |
| 2. Pre-Amplifier output     | 8. Analogue input 3         | 14. Digital input 9  |
| 3. Pre-Amplifier output     | 9. Analogue input 2         | 15. Digital input 8  |
| 4. Zone 2 (& tape) output   | 10. Analogue input 1        | 16. Digital input 7  |
| 5. Analogue input 6         | <b>11. PSX-R connection</b> | 17. Headphone socket |
| 6. Analogue input 5         | 12. Digital input 11 (USB)  | 18. Power inlet      |

## **Connecting to the AC Mains Supply**

Connect the socket on the AC Power cable to the Power inlet Ⓜ on the rear panel of the amplifier. Now connect the cable to a suitable AC power point.

NOTE: The means to disconnect this product from the mains supply is the mains plug. Ensure that the mains plug is accessible at all times.

## **Important – read before making any audio connections**

To avoid possible damage to your amplifier, it is essential to disconnect all system components from the mains supply before connecting or disconnecting audio interconnects.

## **Connecting Analogue Audio Sources**

Analogue Inputs 1-6 are available for the connection of stereo analogue audio sources including -

- Analogue output from CD/DVD Players
- Analogue output from DAB or FM Radio tuners
- Phono pre-amplifier for a turntable
- Televisions
- Analogue Satellite Receivers
- Analogue Tape/Disc recorders
- Cyrus surround decoder

The factory set input names for some of the inputs are pre-set as follows:

Input 1 – CD

Input 2 – Tuner

Input 3 – Cyrus AV (for a Cyrus AV surround processor)

Input 6 – Tape

All inputs may be re-named, but for convenience you may prefer to connect these sources to the pre-named inputs.

Analogue Input 6 is recommended for connection of Tape Recorders. This input is not selectable for recording purposes to avoid howl-round with Tape Recorders, nor is it available to play in a Zone 2 system.

To connect an Analogue Audio source to your amplifier, connect a stereo audio interconnect cable between each component and the sockets as marked on the rear panel. Ensure left and right channels are correctly connected. Make a note of the input number used for each source as the inputs can be re-named at the set-up stage.

## **Connecting a Turntable**

To play a turntable through your unit an external phono pre-amplifier is required. This may then be connected to one of the Analogue inputs.

## **Digital Audio Inputs**

### **Connecting digital audio sources**

The digital audio inputs are compatible with a number of different digital audio sources. These include-

- PC or MAC computer via a USB cable
- Digital Audio output from a CD player
- Digital Radio
- DVD players (for replay of 2 channel PCM programs only)
- Digital Satellite receivers (for replay of 2 channel PCM programs only)
- Digital tape/disc recorders

Using a suitable Toslink optical or Digital phono interconnect, connect each digital audio source to one of the inputs 7-10. Make a note of the input number used for each source as the inputs can be re-named at the set-up stage.

### **Connecting USB audio sources**

The USB audio input 11 may be used to connect the audio feed from a computer. Using a suitable USB cable, connect the USB output from the computer to the USB input Ⓜ.

NOTE: The USB Audio input is configured for USB slave operation and is not suitable for connection of USB drives or other flash media.



### **Connecting a Power Amplifier/Speakers**

The **Cyrus Pre DAC** requires an external power amplifier to drive the system loudspeakers. To connect the power amplifier, connect a phono interconnect from one set of the dual Pre Out sockets (② or ③) to the Inputs of the power amplifier. Ensure left and right channels are correctly connected. The speakers connect to the power amplifier. The power amplifier handbook will include instructions for connection of the speakers.

### **Using the Zone 2 output**

Your product includes a Zone 2 pre-amp output that can be used by a system in a second room. You can then extend the sound from the sources in your main system to a second zone. To use the Zone 2 output you will need a set of long interconnects and an amplifier with loudspeakers in the second zone that has its own volume control. Typically the second zone system would be the auxiliary input of an MP3 player dock or could even be another integrated amplifier with full size separate loudspeakers.

#### **Setting up Zone 2 with powered speakers**

To set up Zone 2, connect the long phono cables to the Zone 2 output ④ and route them to the line inputs of the powered speakers in Zone 2.

#### **Setting up Zone 2 with a second amplifier**

To set up Zone 2 with a separate amplifier, connect the long phono cables to the Zone 2 output ④ and route them to one of the line inputs of the amplifier in Zone 2. Connect the Zone 2 speakers to the Zone 2 amplifier.

NOTE: Amplifiers for Zone 2 use must include a volume control.

#### **Connecting a Tape/Disc recorder for recording**

When not in use for a Zone 2 system, the dual-purpose output Zone 2/Tape may be used to connect a tape recorder for recording purposes. To set up a tape recording loop, connect a phono cable from the 'Input' or 'Record' sockets of the tape deck to the Zone 2 Output ④ sockets.

NOTE: This section assumes that the 'Play' or 'Line Out' sockets of the tape/disc recorder have already been connected to Input 6 for playback purposes.

## Bi-amping

The twin pre-amplifier outputs may be used in conjunction with added power amplifier(s) to significantly upgrade your loudspeaker system through Bi-amping. The Cyrus range of power amplifiers is recommended for this application.

NOTE: A bi-amp system can only be set up with speakers that have bi-wire connections (separate bass and treble connections).

### Connecting power amplifiers:

Two power amplifiers will be required to partner a **Cyrus Pre DAC** pre-amplifier in a bi-amplified system.

Both stereo and high power monobloc Cyrus power amplifiers are available to partner your amplifier.

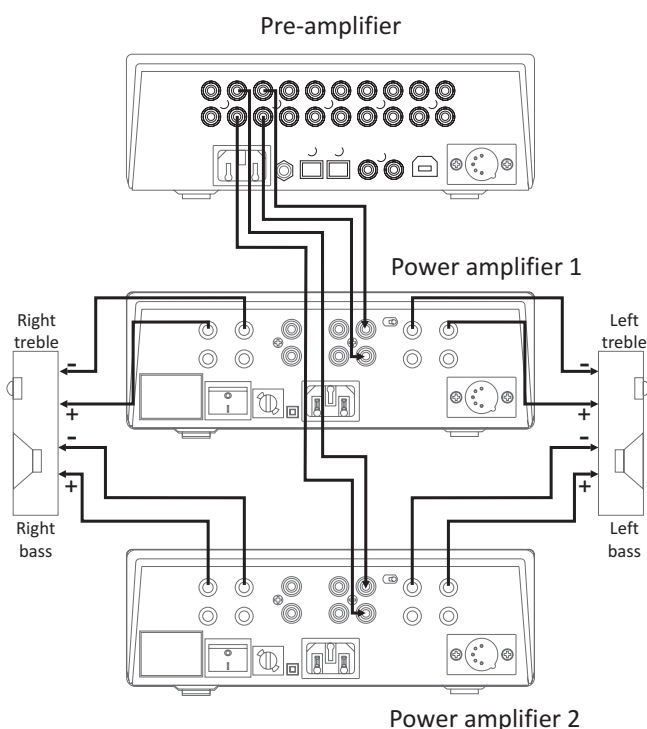

### Connecting a bi-amplified speaker system to a pre-amplifier

NOTE:- Refer to the wiring plan of a bi-amplified system. Take care to connect each of the amplifier output channels to the correct power amplifier and loudspeaker.

## Connecting Headphones

The headphones socket  is a standard 3.5mm stereo jack socket for connection to a pair of headphones. Headphones may be permanently connected to the amplifier and selected when required with the front panel switch.

## Connecting a Cyrus Surround Sound decoder

If your system includes a Cyrus multi-channel surround sound decoder, it may be connected through your stereo amplifier to share the main front speakers of your system.

In this case, connect a stereo phono interconnect from the front channel outputs of the surround decoder to one of the Analogue Inputs of the amplifier. For this system to function correctly both the amplifier and the Cyrus surround decoder must be included in an MC-BUS connection loop and the 'Cyrus AV' input name must be set for the input used (see 'MC-BUS' section and 'Input names' in the 'Setup menu' section).

When set up in this way, the amplifier will automatically check for the presence of the decoder when the 'Cyrus AV' input is selected, then lock its volume setting to an appropriate level.

## Connecting a Surround Sound decoder (other brand)

If your system includes a multi-channel surround sound decoder (but not a Cyrus model), it may be connected through your amplifier to drive the front channel speakers.

In this case, connect a stereo phono interconnect from the front channel outputs of the surround decoder to one of the Analogue Inputs of the amplifier. For this system to function correctly, the 'AV Direct' input name must be set for the input used (see 'Input names' in the 'Setup menu' section).

When set up in this way, the amplifier will automatically lock its volume setting to a fixed level to match the output of the surround decoder.

CAUTION: The 'AV Direct' input name should only be used for surround decoders that include a volume control, as the volume control of your amplifier will be fixed at a very high level.

**MC-BUS System**

Connecting the MC-BUS sockets ① in an MC-BUS system provides unified system control.

An MC-BUS loop is established by connecting single phono cables from the MC-BUS output of one unit to the MC-BUS input of another in a daisy-chain. Complete the loop by returning the MC-BUS output of the final component to the MC-BUS input of the first.

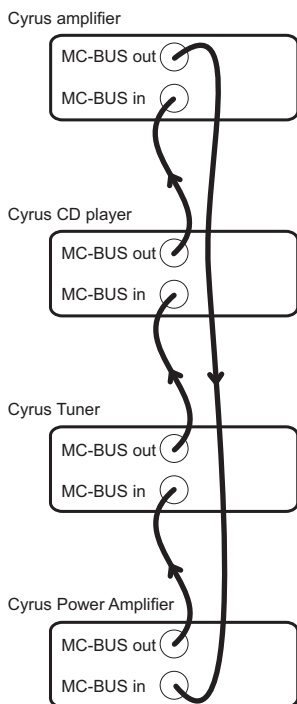

With MC-BUS connection established you can control the power function of the entire system from the front panel or remote control. Selecting 'CD' from the front panel will switch on the amplifier, the Cyrus power amplifier and a Cyrus CD player. When the amplifier is set to Standby, the entire system will also switch off.

When a Cyrus Surround Processor is included in the MC-BUS loop, setting of the volume calibration level will take place automatically when the 'Cyrus AV' input is selected. Refer to the handbook for the Surround Processor for further details.

**External Power Supply - PSX-R**

The **PSX-R** is a unique DC power supply which will upgrade the sonic performance of your amplifier. When an amplifier / **PSX-R** combination is installed, analogue and signal related sections of the amplifier are powered from this clean, stable power source while other requirements are supplied internally. This ensures complete isolation of control circuits and sensitive analogue sections reducing AC mains-borne noise and power supply ripple.

To connect the **PSX-R** to the amplifier, disconnect both components from the mains, then plug the connector on the umbilical cord of the **PSX-R** into the Multi-Pole socket on the rear of the amplifier. You will need a mains supply for both units.

NOTE: Connection of a **PSX-R** is detected automatically by the amplifier, so no internal adjustments are required.

## CONFIGURATION

Through the setup menu you can customise your amplifier to best match your system.

To enter the menu system, press the front panel SETUP key ④. Turn the Rotary control ⑤ to scroll through the options available on the display. Press the Rotary control ⑤ to select the option displayed. During the setup sequence, you can move to the next or previous step by pressing the Input up or down buttons.

Press the SETUP ④ key to exit setup and save any changed settings. Note that the setup sequence will exit, saving any changed settings after 10 seconds of inactivity or after the last option 'Trim input 11' has been completed.

The setup menu options are shown here –

Setup	
↳ Name Input 1	→ Choose a name for input 1 from the name list
↳ Name Input 2	→ Choose a name for input 2 from the name list
↳ Name Input 3	→ Choose a name for input 3 from the name list
↳ Name Input 4	→ Choose a name for input 4 from the name list
↳ Name Input 5	→ Choose a name for input 5 from the name list
↳ Name Input 6	→ Choose a name for input 6 from the name list
↳ Name Input 7*	→ Choose a name for input 7 from the name list
↳ Name Input 8*	→ Choose a name for input 8 from the name list
↳ Name Input 9*	→ Choose a name for input 9 from the name list
↳ Name Input 10*	→ Choose a name for input 10 from the name list
↳ Name Input 11*	→ Choose a name for input 11 from the name list
↳ Input 11 auto-hide*	→ Choose on or off (default is off)
↳ Display Mode	→ Select large input, small input or large volume
↳ Trim Input 1	→ Set the sensitivity offset for input 1
↳ Trim input 2	→ Set the sensitivity offset for input 2
↳ Trim input 3	→ Set the sensitivity offset for input 3
↳ Trim input 4	→ Set the sensitivity offset for input 4
↳ Trim input 5	→ Set the sensitivity offset for input 5
↳ Trim input 6	→ Set the sensitivity offset for input 6
↳ Trim input 7*	→ Set the sensitivity offset for input 7
↳ Trim input 8*	→ Set the sensitivity offset for input 8
↳ Trim input 9*	→ Set the sensitivity offset for input 9
↳ Trim input 10*	→ Set the sensitivity offset for input 10
↳ Trim input 11*	→ Set the sensitivity offset for input 11
↳ The display will show 'Storing Settings', then exit setup.	

## Input names

When your amplifier left the factory, the input names are set as shown below

Input 1 – CD	Input 5 – Input 5	Input 9 – Input 9
Input 2 – Tuner	Input 6 – Tape	Input 10 – Input 10
Input 3 – Cyrus AV	Input 7 – Input 7	Input 11 – Input 11
Input 4 – Input 4	Input 8 – Input 8	

The name of any input may be changed to a choice from the following list. Each name may be used once -

CD, DAB, Cyrus AV\*, Phono, Tape 3-Head, Tape, Satellite, Cable, iPod, MP3, DVD, Blu-ray, CD 1, CD 2, SACD, CD-R, Linkserver, Jukebox, LaserDisc, Tuner, AV Direct\*, TV, TV 1, AV, USB, Satellite 1, Cable 1, Video, VCR, PVR, Cassette, DAT, MiniDisc, Games, Games 1, PC, Laptop, Mac, Special, Keyboard, Aux, Stream X.

Before changing the names of the inputs, we recommend making a list of each input number with your preferred name from the choices above before setting the names. Each name may only be used once. When a name is assigned to an input it will be removed from the list for other inputs.

NOTE:- There are two special function input names marked \*.

'Cyrus AV' is reserved for the connection of Cyrus surround sound decoders to one of the analogue Inputs 1-6 and should only be used for this purpose.

'AV Direct' is reserved for the connection of non-Cyrus surround decoders to an analogue input. This input name must only be used for this purpose as the volume level will lock to a very high setting (-6dB) when AV Direct is selected.

Choose 'No source' from the list to name inputs which have no source connected to them. When named 'No Source', an input number will not appear in the input selector scroll sequence or in the Zone 2 select sequence.

In addition, the name 'Tape 3-Head' will appear as an extra option in the naming list for Input 6, and the name 'USB' will appear in the list for Input 11.

## Input 11 auto-hide

The USB input has a special 'auto-hide' feature. If this feature is switched on, the USB input will only appear in the input selector scroll sequence when a valid source is connected to the USB input. If no source is connected or if the source is switched off, Input 11 will not appear in the sequence.

### Display mode

There are three modes of display operation.

The 'small input' setting will show a three line display with the volume reading at the top of the display, the selected input in the display centre and the current sample rate/lock status at the bottom when a digital input is selected.



The 'large input' setting will show a two line display with the volume reading at the top and a larger input legend below.



The 'large volume' setting will display large volume characters at the bottom of the screen with the bargraph above.



### Input sensitivity offset

It is possible to adjust the relative sensitivity of individual inputs by selecting the appropriate trim option from the menu. This enables the volume level when playing low or high output source components such as tape decks or tuners to be equalized between system sources.

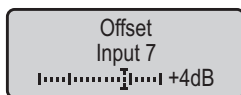

### Factory Settings

You can restore the configuration of your amplifier to the factory original settings, changing the input names to those listed above, setting the display mode to 'small input names' and setting all input sensitivity trim settings to 0dB.

To restore the settings, first disconnect the power cord from the amplifier. Hold down the setup key on the front panel and re-connect the power cord.

## OPERATION

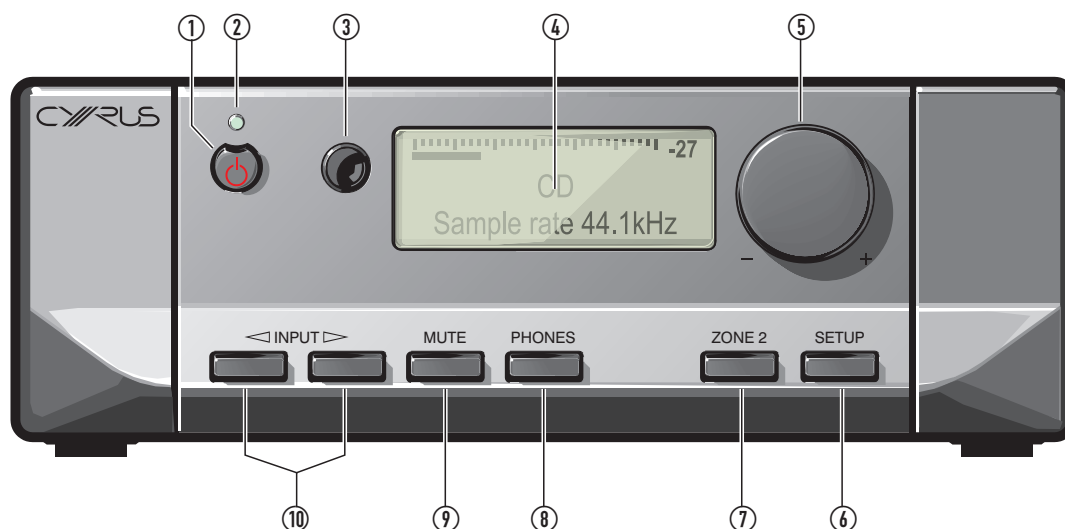

### Key to the front panel drawing:

- |                                   |                      |
|-----------------------------------|----------------------|
| 1. Standby switch                 | 6. Setup select      |
| 2. Standby light                  | 7. Zone 2 select     |
| 3. Remote eye                     | 8. Headphones select |
| 4. Display window                 | 9. Mute select       |
| 5. Level control and setup adjust | 10. Input select     |

### Power

When power is applied, the STANDBY key ① is used for power control. The Standby light ② shows green when the amplifier is operating and glows red when in standby mode.

In regular use the amplifier should be connected permanently to the mains power supply. When left unattended for a long period (holidays etc) it should be disconnected from the AC supply.

When the amplifier is switched to Standby, all settings for input selection and Volume/Balance are retained.

### Selecting an Input

Inputs may be selected from the front panel INPUT SELECT keys ⑩ or with the remote control INPUT SELECT keys. Press the up or down button to scroll up or down through the inputs available.

NOTE: A choice of three styles is available for appearance of the front panel display. These may be selected through the setup menu. The factory default setting - 'small input' display will also identify the sample rate of the selected source (digital inputs only) and indicate 'Invalid Audio Format' for program material which cannot be decoded (such as multi-channel digital sound from DVD players).

### Selecting the 'Cyrus AV' or 'AV Direct' Inputs

The 'Cyrus AV' and 'AV Direct' input names are reserved only for use with surround-sound decoders. When one of these inputs is selected, the volume control on the amplifier will lock and the surround decoder input select and volume controls are used to select a multi-channel source and set the volume level for the system.

To unlock the volume control and return to playing a stereo source, select the input you want to play at the amplifier.

NOTE:- The Zone 2 select key will function when 'Cyrus AV' or 'AV Direct' are selected.

## Volume and Balance

The level control ⑤ performs the dual functions of volume and balance.

**Volume:** In normal mode the level control sets the volume in 1dB steps. A bargraph and a numeric scale at the top of the display window show the current volume setting. The last used volume setting is stored when the unit is set to standby.

If the volume is set to an abnormally high volume level (greater than  $-15\text{dB}$ ) before entering standby, the level will be reduced automatically to a safer level of  $-15\text{dB}$  for next use. Similarly, the volume will be reduced to a safer level if the amplifier was muted while set to a high volume setting, or after listening to headphones at a high volume setting.

**Balance:** Press the balance control key on the remote control to change the mode of the front panel rotary control ⑥ to set Left/Right Balance.

The volume display will change to show a graphic display of the balance setting.

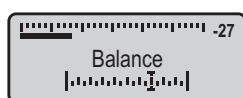

The balance may be adjusted in 1 dB steps by up to 4dB toward the left or right channels by turning the level control or pressing the volume up/down keys on the remote control.

After the 4dB setting, one further step will swing the sound balance completely to the left or right speaker. This setting may be useful when checking if the system channels are working correctly etc.

## Mute

Pressing the MUTE Key ⑨ will mute the volume to minimum level without disturbing the existing volume setting. When muted the display will show that the volume is muted. Press the MUTE key again or move the volume knob up to fade back up to the original volume setting.

## Listening to headphones

To listen to headphones, first connect your headphones to the 3.5mm headphone jack on the back panel of the amplifier. Press the PHONES key ⑩. The display will briefly show the legend 'Headphones On', the sound will fade down in the speakers, and fade up in the headphones. To return to speaker operation, press the PHONES key ⑩ again.

NOTE: The PHONES key ⑩ only operates when headphones are connected to the rear panel socket.

Warning: Excessive sound pressure from earphones and headphones can cause hearing loss.

Caution: If you have been listening to headphones at high volume, be sure to turn the level down before you switch to normal loudspeaker operation.

## Playing music in Zone 2

As supplied from the factory, the Zone 2 system will always play the same source as the main system. Changing the main system source will also change the source playing in Zone 2.

If required, it is also possible to select a different source for Zone 2 from the main system.

To select a different source, press the front panel Zone 2 key, the display will show the input source currently selected for Zone 2.

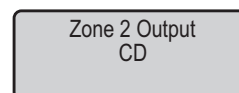

While the Zone 2 indication is showing on the display, turn the rotary control to select a different source for Zone 2. Press the Zone 2 key again to confirm selection of the input source displayed.

NOTE: If a digital input is selected for the main system, then this will be the only digital source selectable for Zone 2. If an analogue source is playing in the main system, then all digital sources will be selectable for Zone 2.

NOTE: Input 6 is reserved for connection to a Tape Recorder, so is not selectable for Zone 2/Recording purposes.

**Tape/Disc Playback and Recording**

Playback: You can play back a recording by selecting the Analogue Input to which you connected your tape recorder.

Recording: If you have connected the Zone 2/Tape output sockets to the input of your tape recorder, you can make recordings from the input sources connected to your amplifier.

As supplied from the factory, the recording signal will always track the same source as the main system is playing. You can however, select a different source for recording if required. To change the source, press the front panel Zone 2 key to display the input source currently selected for recording.

While the Zone 2 indication is showing on the display, turn the rotary control to select a different source. Press the Zone 2 key again to confirm selection of the input source displayed.

NOTE: Input 6 is recommended for playback connection of a Tape Recorder as it is not selectable for Zone 2/Recording purposes.



## REMOTE CONTROL OPERATION

### Remote control introduction:

The iR14 remote control will send commands to Cyrus amplifiers, CD players and Audio streamers\*.

The remote control can also be programmed with the commands from two other remote control handsets. These will normally be for your TV and a Satellite or terrestrial TV set-top box, programmed to the TV and SAT buttons, but could also be other audio components such as a Cyrus tuner or DVD player etc.

\*NOTE: It may be necessary to upgrade the firmware in an Audio streamer to enable Infra-red remote control operation.

### Remote control backlight:

The remote control keypad includes a back-light. The back-light will switch on automatically when moved or when a command is sent.

### Fitting batteries to the remote control:

The battery compartment is on the back of the remote control.

1. Press the catch on the battery cover and lift off the cover.
2. Slide a AAA battery under the retaining hook in the upper half of the battery compartment as shown.
3. Fit a second AAA battery into the remaining space.
4. Replace the battery cover.

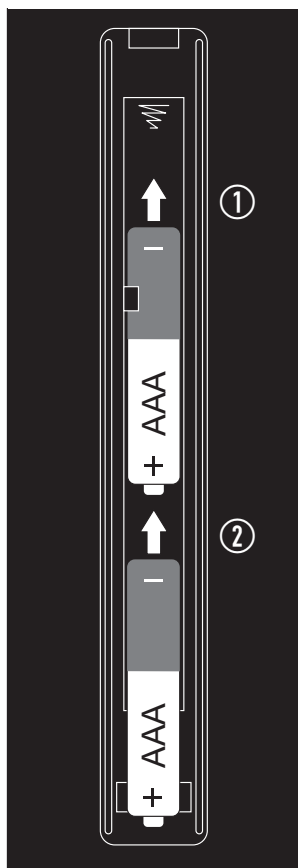

Replace the handset batteries only with AAA batteries of the same voltage and type.

Discard used batteries in accordance with recycling regulations in force in your area.

### Sending commands to Cyrus components:

- Press the CYRUS key to set the remote control to Cyrus mode.



### Switching on Cyrus components:

Press one of the keys in the SOURCE group.

- Press ◀ or ▶ to switch on and send commands to a Cyrus amplifier.

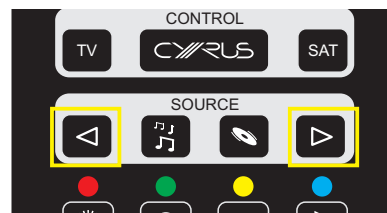

- Press the CD key to switch on a Cyrus CD player and send commands to a Cyrus CD player and amplifier.

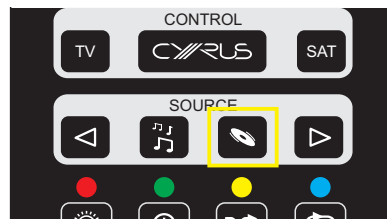

- Press the AUDIO key to switch on a Cyrus Audio streamer and send commands to a Cyrus Audio streamer and amplifier.

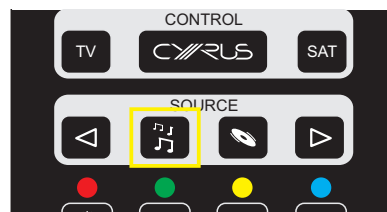

NOTE: If amplifier inputs have been named CD and/or Stream X, the correct amplifier input will also be selected.

**Cyrus amplifier commands**

- Press the CYRUS key to set the remote control to Cyrus mode.

You can now control the Cyrus amplifier. The CYRUS key will flash red when commands are being sent in Amplifier mode.

The Amplifier mode commands available are listed below –

1. Set Cyrus amplifiers, CD players and Audio streamers to Standby.
2. Set the handset to send commands to Cyrus components.
3. Send commands to a Satellite receiver (or other device programmed to use this key).
4. Set the handset to send commands to an amplifier and CD player.
5. Step to the next amplifier input.
6. No command for an amplifier.
7. No command for an amplifier.
8. No command for an amplifier.
9. No command for an amplifier.
10. No command for an amplifier.
11. No command for an amplifier.
12. No command for an amplifier.
13. Amplifier mute.
14. No command for an amplifier.
15. No command for an amplifier.
16. No command for an amplifier.
17. No command for an amplifier.
18. No command for an amplifier.
19. No command for an amplifier.
20. No command for an amplifier.
21. No command for an amplifier.
22. Setup key for programming TV/SAT keys.
23. No command for an amplifier.
24. No command for an amplifier.
25. No command for an amplifier.
26. No command for an amplifier.
27. No command for an amplifier.
28. Volume down.
29. Volume up.
30. Balance.
31. No command for an amplifier.
32. No command for an amplifier.
33. No command for an amplifier.
34. No command for an amplifier.
35. Display off.
36. No command for an amplifier.
37. Step to the previous input.

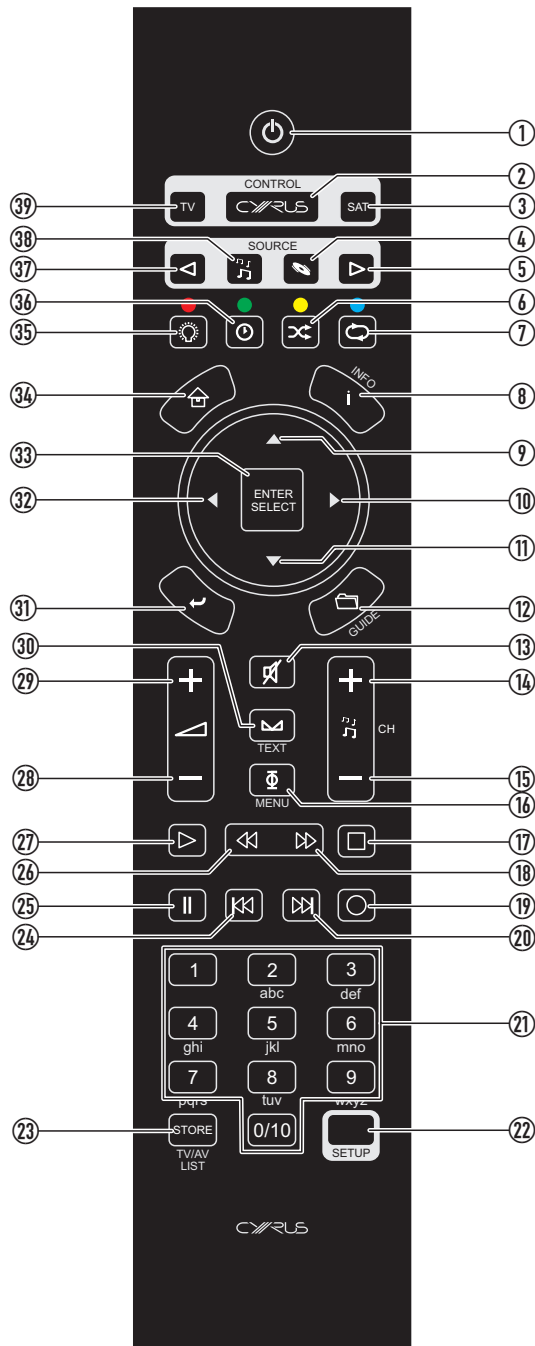

38. Set the handset to send commands to an amplifier and Audio streamer.
39. Send commands to a TV (or other device programmed to use this key).

## Cyrus CD player commands

- Press the CYRUS key
- Press the  key to set the remote control to CD mode.

The key will light red. You can now control both a Cyrus CD player and amplifier. The  key will flash red when commands are being sent in CD mode.

The CD mode commands available are listed below –

1. Set Cyrus amplifiers, CD players and Audio streamers to Standby.
2. Set the handset to send commands to an amplifier.
3. Send commands to a Satellite receiver (or other device programmed to use this key).
4. Set the handset to send commands to an amplifier and CD player.
5. Step to the next amplifier input.
6. No command for a CD player.
7. CD player repeat.
8. No command for a CD player.
9. CD player next track.
10. CD player search forwards.
11. CD player previous track.
12. No command for a CD player.
13. Amplifier mute.
14. No command for a CD player.
15. No command for a CD player.
16. CD player audio phase. Changes in phase are subtle and are best established from the listening position. When the phase setting is changed, the display text area will show the message 'Phase Normal' or 'Phase Invert'. The performance of the CD player is unaffected whether the signal is in normal or phase inverted mode.
17. CD player stop.
18. CD player search forwards.
19. No command for a CD player.
20. CD player next track.
21. CD player numeric keypad. Enter a one or two digit track number to jump to a specific track.
22. Setup key for programming TV/SAT keys.
23. CD player memory store.
24. CD player previous track.
25. CD player pause.
26. CD player search back.
27. CD player play/pause.
28. Amplifier volume down.
29. Amplifier volume up.
30. Amplifier balance.
31. No command for a CD player.
32. CD player search back.
33. No command for an CD player.

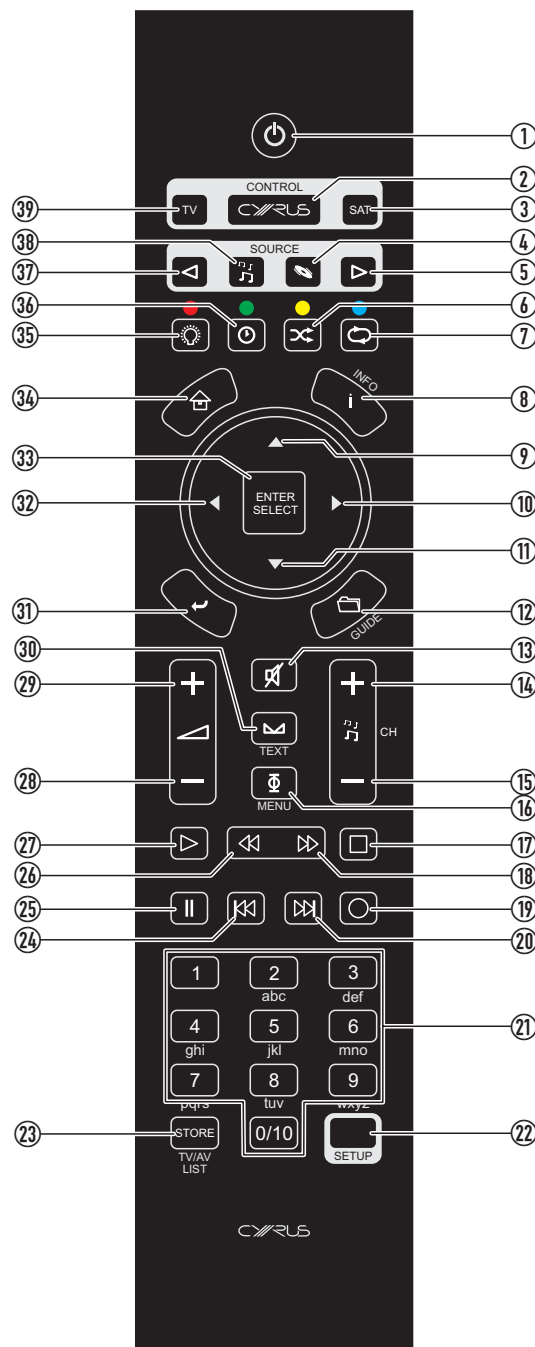

34. No command for a CD player.
35. CD player display off.
36. CD player display mode. Choose track elapsed time or disc remaining time.
37. Step to the previous amplifier input.
38. Set the handset to send commands to an amplifier and Audio streamer.
39. Send commands to a TV (or other device programmed to use this key).

**Cyrus Audio streamer commands**

- Press the CYRUS key
- Press the  key to set the remote control to Audio streamer mode.

The key will light red. You can now control both a Cyrus Audio streamer and amplifier or an Audio streamer that includes an amplifier. The  key will flash red when commands are being sent in Audio streamer mode.

The Audio streamer mode commands available are listed below –

1. Set Cyrus amplifiers, CD players and Audio streamers to Standby.
2. Set the handset to send commands to a Cyrus amplifier.
3. Send commands to a Satellite receiver (or other device programmed to use this key).
4. Select an input named CD and set the handset to send commands to an amplifier and CD player.
5. Step to the next amplifier input.
6. No command for an audio streamer.
7. Audio streamer repeat.
8. Audio streamer display information.
9. Audio streamer cursor up.
10. Audio streamer cursor right.
11. Audio streamer cursor down.
12. No command for an audio streamer.
13. Amplifier mute.
14. No command for an audio streamer.
15. No command for an audio streamer.
16. No command for an audio streamer.
17. Audio streamer stop.
18. No command for an audio streamer.
19. No command for an Audio streamer.
20. Audio streamer next track.
21. Audio streamer alpha-numeric keypad.
22. Setup key for programming TV/SAT keys.
23. No command for an Audio streamer.
24. Audio streamer previous track.
25. Audio streamer pause.
26. No command for an audio streamer.
27. Audio streamer play/pause.
28. Amplifier volume down.
29. Amplifier volume up.
30. Amplifier balance.
31. Audio streamer back.
32. Audio streamer cursor left.
33. Audio streamer select.
34. Audio streamer home.
35. Audio streamer display off.
36. No command for an Audio streamer.
37. Step to the previous amplifier input.

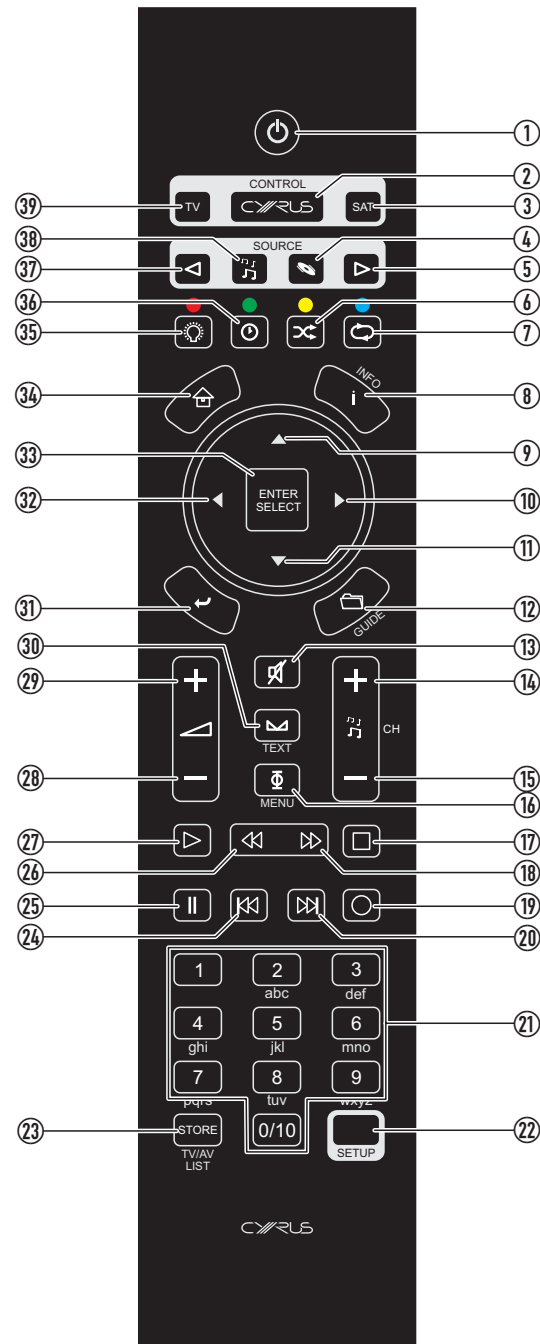

38. Set the handset to send commands to an amplifier and Audio streamer.
39. Send commands to a TV (or other device programmed to use this key).

### Learning TV and Satellite commands

In addition to controlling Cyrus components, the remote control can learn the commands from two other remote control handsets. These will normally be a TV and a Satellite or terrestrial TV set-top box, programmed to the TV and SAT buttons, but could also be other audio components including a Cyrus tuner or DVD player etc.

All keys may be programmed with the exception of the groups marked CONTROL and SOURCE and the SETUP key.

#### Preparation for learning:

Check the following points before attempting to learn any commands -

- Check that both remote controls have fresh batteries.
- Choose a location on a tabletop that is not brightly lit. Subdued light is better, away from bright natural or indoor lighting.
- Check that you have enough time to spare to complete the learning process for all the keys you want to use.

#### Learning commands:

In this example, the Cyrus remote control will be learning commands from a 'reference' Satellite receiver remote control.

1. Set the two remote controls up facing each other, spaced by about 5cm.

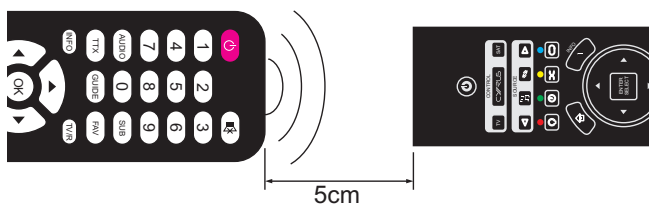

2. Press the TV or SAT key to select the mode that you want to program.

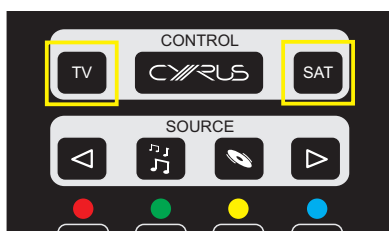

The keypad will light and the key you selected will be red.

3. Press and hold the SETUP key.



The mode key will change to white. After about three seconds, the mode key will light red again. This indicates that the remote control is ready to learn codes.

4. Release the SETUP key.

The remote control is now waiting to learn commands. The keypad will light continually and the mode key will light pale red.

5. On the reference remote control, press and hold the first key you want to learn (for example, volume up) until the mode key flashes red.

This indicates that the command has been received.

6. Release the key on the reference remote control.

7. Press a key on the Cyrus remote control (volume up in this example) to select where you want to save that command.

The mode key will stop flashing. This indicates that the command has been saved successfully.

If the learning process was successful, the remote control will be ready to learn the next command.

8. Repeat steps 5 to 7 for each command you want to learn.

When you have completed learning all commands -

- Press the SETUP key.

The mode key will change to white. After a few seconds the backlight will switch off.

**Checking programmed commands:**

- Select the mode that you just programmed and check that the commands were learned successfully.

NOTE: The TV or SAT mode key should flash red when sending a command. If the mode key is not flashing, then the command has not learned correctly.

- Make a note of any commands that have not programmed correctly and repeat the learning process to add these in.

NOTE: When you start the learning process it does not erase any programmed keys so you can re-program individual keys if required.

**Problems with learning:**

If none of the commands have learned correctly, try re-starting the learning process again. Test a few keys first to ensure that your handset is compatible for learning. If the test works then continue to program the rest of the commands you need.

If you still have problems, check carefully that the mode light is flashing correctly as you send a command to learn. If not, it may be that the batteries need replacement in the reference handset or that the spacing between the handsets is not ideal. Try adjusting the spacing between the handsets and repeating the learning process.

If you continue to have problems, it may be that your handset is incompatible with the learning process. This could happen with an older design of handset or one that has an unusual code-set.

**Sending TV or SAT commands**

Once you have programmed all the keys with the commands you want, you can use the remote control to send commands to your TV or Satellite receiver etc.

- Press the TV or SAT key to select the mode you want.
- Press the command key.

The mode key will flash red when sending a programmed command.

**TROUBLESHOOTING GUIDE**

If your amplifier is not operating properly, disconnect the power and check carefully all connections.

If you are in any doubt, consult your retailer.

<b>No sound</b>	
The amplifier is switched off or in Standby	Bring the unit out of Standby (Standby light - GREEN)
Mute is on	Deselect Mute
The source is not working (e.g. CD not playing or paused)	Check the source
The power amplifier may not be switched on.	Check that the power amplifier is switched on.
<b>No sound (digital sources)</b>	
The sample rate or sound format of the digital signal from the source may not be correct.	Check that the sample rate from the source is within the specification of the amplifier and that the program is encoded as two channel stereo.
<b>No sound from one loudspeaker</b>	
BAL control at extreme limit	Centralise Balance
Does your speaker have fuses?	Check speaker, replace fuses
Speaker cables / interconnects faulty	Check connections, cables - replace if needed
<b>Spurious noises from speakers</b>	
Interconnects or connections faulty	Check, replace where necessary
<b>Only one digital source is selectable for Zone 2</b>	
If a digital input is selected for the main system, then this will be the only digital source selectable for Zone 2. If an analogue source is playing in the main system, then all digital sources will be selectable for Zone 2.	
<b>Remote control not working</b>	
Remote control not operating	Check batteries

**SPECIFICATIONS****Power Supply**

Voltage: ..... As plate on rear of unit

**Power Consumption**

Standby..... <1W

Maximum ..... 18W

Safety Compliance ..... CE

EMC (230V)..... CE

EMC (115V)..... FCC

**Enclosure**

Dimensions (WxHxD)..... 215 x 75 x 365mm

Weight ..... 4.0kg

Material ..... Die cast chassis

**Analogue audio performance**

Input Sensitivity..... 500mV

Input Impedance ..... 40k $\Omega$

Frequency Response (-3dB)..... 0.1Hz, >500kHz

Signal to Noise Ratio (unWTD) ..... 108dB

Output voltage ..... 1V

Max output voltage ..... 3V

Output impedance ..... 120 $\Omega$

THD+N, 1kHz ..... <0.002%

**Digital audio performance**

Input voltage ..... 500mV pk-pk

Input Impedance ..... 75 $\Omega$

Sample rate range ..... 32k - 96k

Audio formats..... PCM stereo only

S/N ratio (Pre-out, 0dB FS) ..... >100dBA

THD+N (Pre-out, 0dB FS) ..... <0.004%

Cyrus reserves the right to change all specifications without notice. E &OE

**WARRANTY**

The warranty should be registered on-line within eight days of purchase. No retailer or distributor may vary the terms of this warranty, which is personal to the original purchaser and is not transferable.

Please retain the sales receipt as proof of purchase.

Warranty claims must wherever possible be made through the retailer from whom the equipment was purchased.

This warranty excludes:

- Damage caused through neglect, accident, misuse, wear and tear, or through incorrect installation, adjustment or repair by unauthorised personnel. Any unauthorised servicing will result in loss of warranty.
- Liability for damage or loss occurring in transit to or from the purchaser.
- Consequential damage, loss or injury, arising from or in conjunction with this equipment.

Equipment for attention under warranty should be consigned return carriage paid. If returned equipment is found to comply with the published specification, CYRUS reserves the right to raise a charge.

The above conditions do not affect your statutory rights as a consumer.

**WEEE**

This logo means that this product is not to be disposed of with your household waste. This product should be handed over to a designated collection point to be recycled. Your cooperation in the correct disposal of this product will contribute to the effective usage of natural resources. For more information on collection points, contact your disposal service or City Hall.







Cyrus Audio Ltd., Ermine Business Park, Huntingdon, PE29 6XY, U.K.