

ONE HD

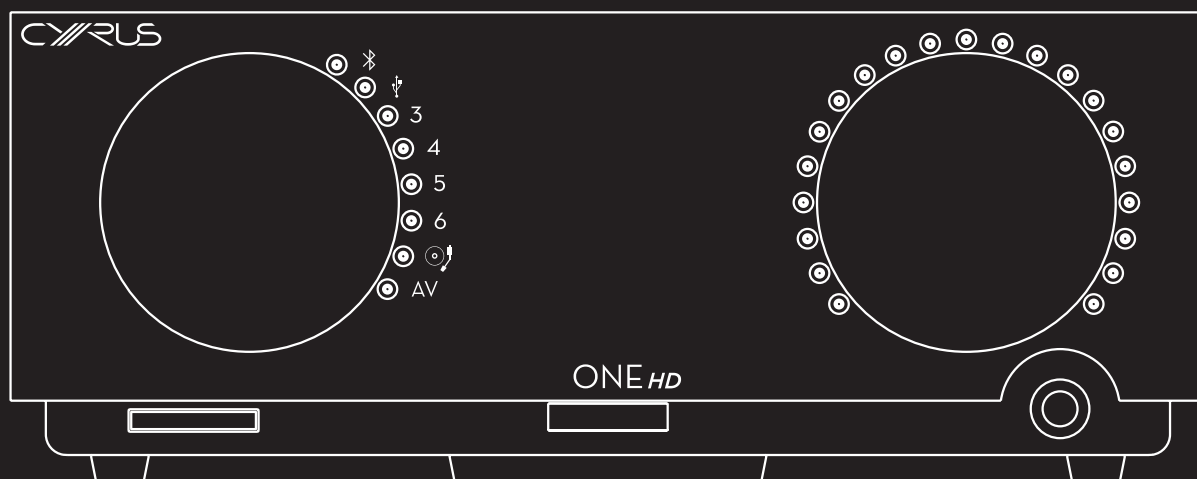

CYRUS

CONTENTS

IMPORTANT! READ BEFORE OPERATING THIS EQUIPMENT! ..	1	ONE REMOTE APP.....	10
Power supply	2	First use	10
Servicing	2	Using the app.....	10
Product service centres	2	Volume control	10
Legal notices	2	Source select.....	10
FCC NOTICE*	3	Mute	10
WELCOME TO THE WORLD OF CYRUS!.....	4	Indicator brightness	10
Preparations for Installation	4	Opening the settings screen	11
INSTALLATION	5	Volume limiter	11
Rear panel.....	5	Channel balance	11
Important – read before connecting anything.....	6	AV Direct mode	11
What can I connect?	6	Device pane	11
Connect a turntable	6	App help screen	11
Connect analogue line audio	6	Feedback	11
Connect digital audio.....	6	Using the app and playing music simultaneously.....	11
Connect USB audio	6	ADVANCED OPERATION	12
Connect speakers.....	6	AV Direct mode.....	12
Cyrus S.I.D. system	6	Setting AV Direct mode.....	12
Connect headphones.....	6	Connecting to a Home Cinema decoder	12
Connect mains power	6	In Use	12
OPERATION	7	Factory reset.....	12
Front panel	7	Resetting the Cyrus ONE <i>HD</i>	12
Power.....	8	TROUBLESHOOTING GUIDE.....	13
Playing <i>Bluetooth</i> ® devices	8	Diagnostic system	14
Multiple devices.....	8	SPECIFICATIONS.....	15
First time use/pairing.....	8	Power Supply	15
Pairing additional devices	8	Power Consumption	15
Re-connecting	8	Enclosure	15
Playing music	8	Analogue audio performance	15
Playing a vinyl turntable	9	Cable and optical digital audio	15
Playing other analogue sources.....	9	USB digital audio.....	15
Playing digital sources.....	9	Digital audio performance at Pre-out.....	15
Playing USB digital audio sources (USB B input).....	9	<i>Bluetooth</i> specification	15
Playing DSD audio (USB B input).....	9	WARRANTY.....	15
Volume.....	9	WEEE.....	15
Listening through headphones.....	9		

IMPORTANT! READ BEFORE OPERATING THIS EQUIPMENT!

CAUTION: The exclamation mark is to draw your attention to important instructions and safety procedures in this manual.



ATTENTION: The lightning flash warns you of the risk of electrical shock presented by components inside this product. Unauthorised personnel must not open this unit.



WARNING: To reduce the risk of electrical shock do not remove any unit covers or panels. There are no user serviceable parts in this product.

WARNING: To reduce the risk of electric shock, do not expose this equipment to rain or moisture.

HEED WARNINGS: All warnings on the product and in the operating instructions should be adhered to.

READ ALL THE INSTRUCTIONS: All the safety and operating instructions should be read before the product is operated.

RETAIN INSTRUCTIONS: The safety and operating instructions should be retained for future reference.

FOLLOW INSTRUCTIONS: All operating and use instructions should be followed.

CLEANING: Unplug this product from the mains before cleaning. Do not use liquid or aerosol cleaners. Use a damp cloth for cleaning.

WATER AND MOISTURE: Do not use this product near water - for example, near a bath tub, wash bowl, kitchen sink, or laundry tub, in a wet basement; or near a swimming pool and the like. The product must not be exposed to dripping or splashing and no objects filled with liquids, such as vases, shall be placed on the product.

HEAT: The product should be situated away from heat sources such as radiators, stoves, or any other products (including amplifiers) that produce heat.

VENTILATION: Slots and openings in the cabinet are provided for ventilation, to ensure reliable operation of the product and to protect it from overheating and these openings must not be blocked or covered. The openings should never be blocked by placing the product on a bed, sofa, rug or similar surface. This product should not be placed in a built-in installation such as a bookcase or rack unless proper ventilation is provided or the manufacturer's instructions have been adhered to.

OBJECT OR LIQUID ENTRY: Never push objects of any kind into this product through openings as they may touch dangerous voltage points or short-out parts that could result in a fire or electric shock.

ACCESSORIES: Do not place this product on an unstable cart, stand, tripod, bracket, or table. The product may fall, causing serious injury to a child or adult, and serious damage to the product. Use only with a cart, stand, tripod, bracket or table recommended by the manufacturer, or sold with the product. Any mounting of the product should follow the manufacturer's instructions, and should use a mounting accessory recommended by the manufacturer.

ATTACHMENTS: Do not use attachments not recommended by the product manufacturer as they may cause hazards.

MOVING THE PRODUCT: A product and cart combination should be moved with care. Sudden stops, excessive force, and uneven surfaces may cause the product and cart to overturn.



POWER SOURCES: This product should be operated only from the type of power source indicated on the marking label. If you are not sure of the type of power supply to your home, consult your product dealer or local power company. For products intended to operate from battery power, or other sources, refer to the operating instructions.

OVERLOADING: Never overload wall outlets, extension cords, or integral convenience receptacles. This can result in an increased risk of fire or electric shock.

POWER CORD PROTECTION: Power supply cords should be routed so that they are not likely to be walked on or pinched by items placed upon or against them, paying particular attention to cords at plugs, convenience receptacles, and the point where they exit from the product.

NAKED FLAMES: No naked flame sources, such as candles, must be placed on this product.

LIGHTNING: For added protection for this product during a lightning storm, or when it is left unattended or unused for long periods of time, unplug it from the wall outlet and disconnect the antenna or cable system. This will prevent damage to the product due to lightning and power-line surges.

BATTERIES: Warning : Batteries shall not be exposed to excessive heat such as sunshine, fire or the like.

CAUTION! POLARISED CONNECTOR (CANADA and USA):

To prevent electrical shock, match wide blade of plug to wide slot, fully insert. Do not alter or remove this plug if it does not fit your mains power socket. Have a suitable socket installed by a competent electrician.

ACCESS TO THE MAINS PLUG: The means to disconnect this product from the mains supply is the mains plug. Ensure that the mains plug is accessible at all times.

WARNING: This appliance must be earthed.



WARNING: To prevent possible hearing damage, do not listen at high volume levels for long periods.

Power supply

The mains supply requirement of your amplifier is marked on a label on the rear panel. Before connecting, check that this voltage is the same as your mains supply.

230V Products: Voltage Range 220V-240V

115V Products: Voltage Range 110V-120V

If you move to an area with a different mains voltage, contact your local Cyrus distributor to have your product converted.

There are no user replaceable fuses in this unit.

Servicing

Do not attempt to service this product yourself as opening or removing covers may expose you to dangerous voltage or other hazards. Refer all servicing to qualified service personnel.

CONDITIONS REQUIRING SERVICE: Unplug this product from the wall outlet and refer servicing to qualified service personnel:

- When the power supply cord or plug is damaged.
- If liquid has been spilled, or objects have fallen into the product.
- If the product has been exposed to rain or water.
- If the product has been dropped or damaged in any way.
- If the product does not operate normally by following the operating instructions. (Adjust only those controls that are covered by the operating instructions. Improper adjustment of other controls may result in damage requiring extensive work by a qualified technician to restore the product to its normal operation).
- When the product exhibits a distinct change in performance.

REPLACEMENT PARTS: When replacement parts are required, be sure the service technician has used replacements specified by the manufacturer or have the same characteristics as the original part. Unauthorised substitutions may result in fire, electric shock, or other hazards.

SAFETY CHECK: Upon completion of any service or repairs to this product, ask the service technician to perform safety checks to determine that the product is in proper operating condition.

Product service centres

For product service or technical advice, contact only authorised Cyrus service centres. Contact details for Cyrus distributors may be found on the Cyrus website at www.cyrusaudio.com.

Legal notices

The **Bluetooth**® word mark and logos are registered trademarks owned by **Bluetooth** SIG, Inc. and any use of such marks by Cyrus is under license. Other trademarks and trade names are those of their respective owners.

Android is a trademark of Google Inc.

iTunes® is a trademark of Apple Inc., registered in the U.S. and other countries.

FCC NOTICE*

NOTE: This equipment has been tested and found to comply with the limits for a Class B digital device, pursuant to Part 15 of the FCC rules. These limits are designed to provide reasonable protection against harmful interference in a residential installation. This equipment generates, uses and can radiate radio frequency energy and, if not installed and used in accordance with the instructions, may cause harmful interference to radio communications. However, there is no guarantee that interference will not occur in a particular installation. If this equipment does cause harmful interference to radio or television reception, which can be determined by turning the equipment off and on, the user is encouraged to try and correct the interference by one or more of the following measures:

- Reorient or relocate the receiving antenna.
- Increase the separation between the equipment and receiver.
- Connect the equipment into an outlet on a circuit different from that to which the receiver is connected.
- Consult the dealer or an experienced radio/TV technician for help.

Any changes or modifications not expressly approved by the manufacturer could void the user's authority to operate the equipment.

*115V products

WELCOME TO THE WORLD OF CYRUS!

Congratulations on your choice of Cyrus Hi-fi products. Our state-of-the-art design technology and outstanding quality of manufacture has won countless awards around the world. We are confident that you will derive great pleasure from owning a product from one of the most recognised and respected manufacturers of hi-fi equipment.

Now is a good time to register your new Cyrus product. To register, visit www.cyrusaudio.com/support and click the 'Register your product' link.

Please read these instructions carefully before commencing installation. They provide full guidance to help you install your amplifier safely and correctly.

Preparations for Installation

Before installing your Cyrus amplifier check that the following items are included in the accessory box.

- Power Cable x 2

After removing these items, please retain the packaging.

Install the amplifier in a well ventilated location away from sources of high temperature, dust or humidity. Never stand the amplifier under another unit or on any surface likely to obstruct its cooling or ventilation.

INSTALLATION

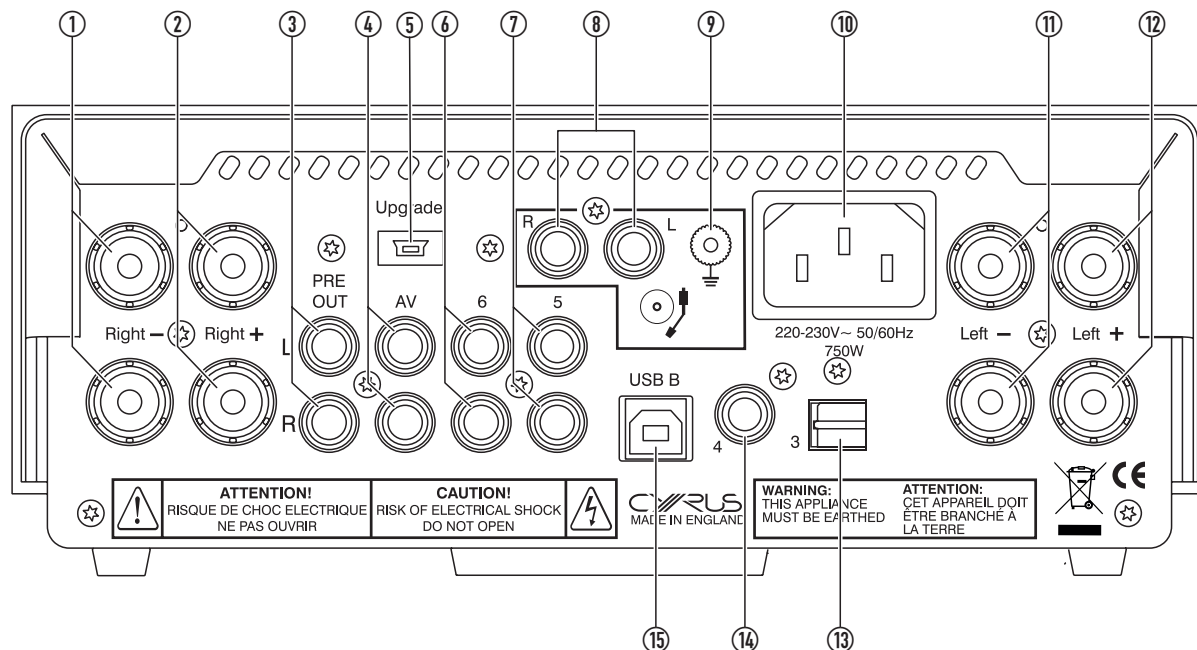

Rear panel

- | | |
|---------------------------|---------------------------|
| 1. Right - speaker output | 9. Turntable ground |
| 2. Right + speaker output | 10. Power inlet |
| 3. Pre-Amp output | 11. Left - speaker output |
| 4. AV input | 12. Left + speaker output |
| 5. Upgrade port | 13. Optical input 3 |
| 6. Line input 6 | 14. Digital input 4 |
| 7. Line input 5 | 15. USB input |
| 8. Turntable input | |

Important – read before connecting anything

Always disconnect all system components from the mains before changing any connections. Connect the mains when everything is hooked up.

When connecting sources avoid the use of long interconnects which may degrade sound quality. The maximum length advised is 3m.

What can I connect?

You can play sound from **Bluetooth** sources such as a phone or a computer.

You can connect a vinyl turntable. It must have a Moving Magnet cartridge. Moving Coil cartridges are not compatible.



You can connect up to 3 x line analogue audio sources such as CD or DVD players, TVs or satellite boxes.

You can connect two digital audio sources. Both cable and optical connection are available.

You can connect USB audio from a computer.

Connect a turntable

The turntable will have a cable with two plugs, and often a thin ground wire with a tag.

- Connect the plugs to the  sockets on the back panel. Connect the white plug to the left socket and the red plug to the right socket.
- Unscrew the ground  terminal then fasten the ground wire under the terminal.

Connect analogue line audio

If you have line audio sources you can connect them to any of the analogue inputs - Input 5, Input 6 or AV.

- Connect a stereo phono interconnect (not supplied) from the outputs of the source to one of these inputs on the back panel.
- Connect the white plugs to the left sockets and the red plugs to the right sockets.

If the source has surround-sound (DVD player etc), check that the source is set to work in two channel stereo mode.

Connect digital audio

If you have digital audio sources you can connect them to Input 3 (optical) or Input 4 (wired).

- For optical digital sources, connect a Toslink optical interconnect (not supplied) from the output of the source to Input 3.
- For wired digital sources, connect a digital phono interconnect (not supplied) from the output of the source to Input 4.

Connect USB audio

If you connect a computer to the USB audio port you can play all audio from the computer through your amplifier.

- Connect a USB A to USB B cable (not supplied) between a free USB port on the computer and the USB B input.

Connect speakers

The amplifier and speaker have red and black speaker terminals. Make sure the red terminal on the amplifier connects to the red terminal on the speaker (and black to black).

- Speaker cables will have a polarity indicator. This is usually a stripe or rib on the wire to show the red connection.
- Connect the striped wire to the red terminal at each end, then connect the other wire to the black terminals.

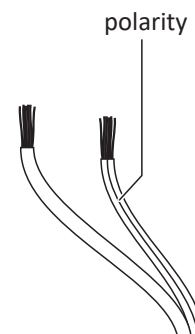

Make sure the left speaker is connected to the left terminals at the amplifier (and right to the right).

Cyrus S.I.D. system

The Cyrus ONE *HD* amplifier features the Cyrus Speaker Impedance Detection (S.I.D.) system. S.I.D. is a technology that optimises the performance of the amplifier to best match the connected loudspeakers.

S.I.D. is not a user-accessible feature, but takes place automatically. Each time the Cyrus ONE is switched on the impedance of the connected loudspeakers is measured and the power amplifier aligned to correctly match that impedance.

To ensure that S.I.D. will function correctly, always follow these guidelines -

- Never switch on the Cyrus ONE *HD* before the speakers are connected.
- Always switch off the Cyrus ONE *HD* if the speakers are to be disconnected and changed to another type.

NOTE: It is possible to hear a low level noise from the left speaker when S.I.D. operates shortly after switching on the Cyrus ONE *HD*. This is normal and does not indicate a fault with the amplifier.

Connect headphones

Connect headphones to the jack on the front panel. When headphones are connected to the amplifier, the speakers will switch off.

The headphone socket is a standard 1/4" (6.35mm) stereo jack. Converters are readily available if you want to use headphones with a smaller (3.5mm) jack.

Connect mains power

When you have finished all other connections, connect mains power.

- Connect the socket on the power cable to the power inlet on the back panel of the amplifier. Now connect the cable to a mains outlet.

NOTE: The means to disconnect this product from the mains supply is the mains plug. Ensure that the mains plug is accessible at all times.

OPERATION

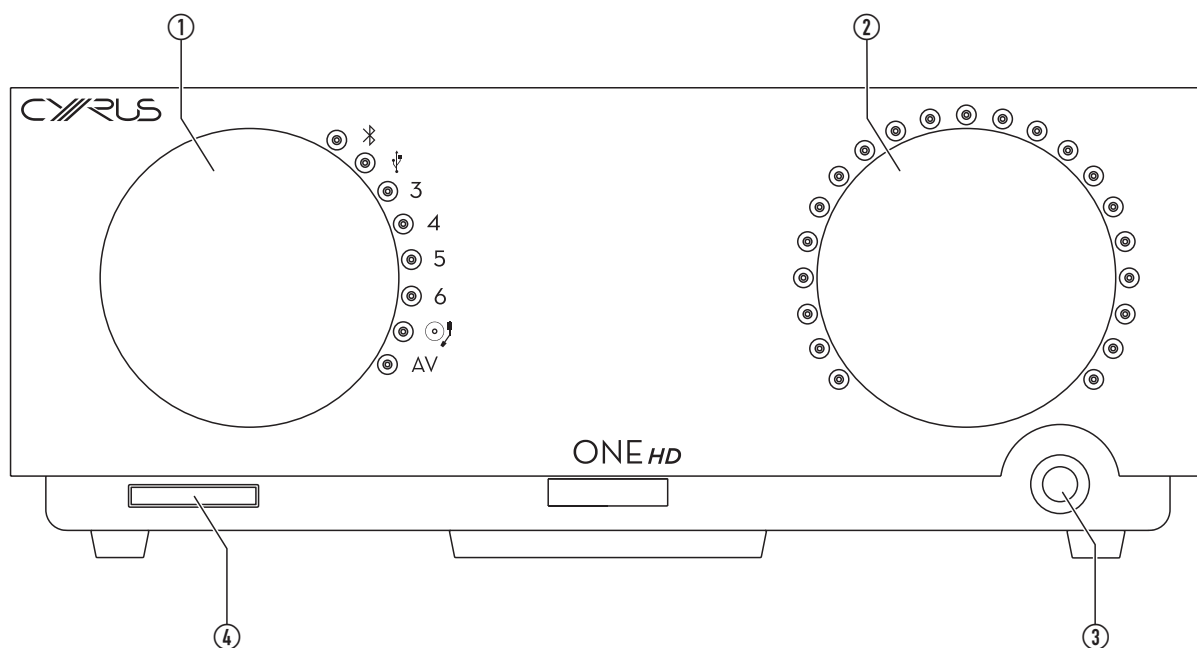

Front panel

- 1. Source selector
- 2. Volume control
- 3. Headphone socket
- 4. Power switch

Power

Power is controlled by the mains power button under the front panel.

- Press the button to switch the amplifier on. Press again to switch the amplifier off.

When the amplifier is switched on the front panel indicators for source and volume level will light.

Playing *Bluetooth*® devices

Multiple devices

The Cyrus ONE *HD* can pair with up to 3 **Bluetooth** sources.

Most sources that have been paired will automatically re-connect when in range, up to the 3 source maximum.

First time use/pairing

- Set the source selector to the **X** position.

*A **Bluetooth** scan will start.*

*If no **Bluetooth** sources are connected, the **Bluetooth** indicator will flash.*

- Activate **Bluetooth** mode on the source.

*If the source is a phone, **Bluetooth** mode will normally be in the connectivity section of the settings menu.*

*If the source is a computer, **Bluetooth** settings should be in the control panel.*

*In the **Bluetooth** menu of the source, there should be an option to search for **Bluetooth** devices.*

- Select this option.

*The source will now scan for **Bluetooth** devices and should find the unit, identified as 'CyrusONEHD', followed with a serial number.*

- Choose to pair with this.

*Your **Bluetooth** source will now connect.*

*NOTE: If the device features **Bluetooth** technology earlier than V2.1, you will be asked for a password.*

- If so, enter 0000.

*If the source connects successfully, the **Bluetooth** indicator will stop flashing.*

Pairing additional devices

Follow the previous section to pair each additional source.

NOTE: If a **Bluetooth** source is already connected the **Bluetooth** indicator will not flash, but the Cyrus ONE *HD* will remain discoverable to other **Bluetooth** sources until the maximum of 3 sources are connected.

Re-connecting

Some devices will re-connect when next in range, others may require manual connection.

Playing music

Once your device is connected you can select the music you want to play from the device and set the volume level etc. at the amplifier.

When multiple devices are connected, the device that is playing will generally hold the **Bluetooth** channel until play stops. Some devices, particularly computers, may hold the **Bluetooth** channel after play stops. In this case the device will need to be disconnected before playing another.

Playing a vinyl turntable

- Set the source selector to the  position.
- Start the record playing.

Playing other analogue sources

- Set the source selector to play the source you want to hear (positions 5, 6 or AV).
- Set the source to play.

Playing digital sources

- Set the source selector to play the source you want to hear (positions 3 or 4).
- Set the source to play.

Playing USB digital audio sources (USB B input)

Sources for USB music will generally be files streamed to or stored on a personal computer.

- Before playing USB music, change the audio settings on the computer to output sound to the Cyrus ONE HD device.
- Set the source selector to the  position.
- Play the music file.

Playing DSD audio (USB B input)

DSD Audio files will also be stored on a personal computer.

Playback of DSD files will require the installation on the computer of a specialist music playback app that supports DSD playback.

- Before playing DSD music, choose, install and configure a DSD player app on the computer.
- Set the source selector to the  position.
- Play the DSD music file.

Volume

- Turn the volume control clockwise to increase the volume or anti-clockwise to reduce the volume.

The volume indicators will show the volume level.

Listening through headphones

- Plug the headphones into the front panel headphone jack.

The speakers will switch off and music will play through the headphones.

Warning: Excessive sound pressure from earphones and headphones can cause hearing loss.

NOTE: The volume will reduce to a low level when you unplug headphones and return to speaker listening.

ONE REMOTE APP

The ONE Remote app is available to enable your Cyrus ONE HD to be controlled from most popular mobile devices when within range of the Cyrus ONE HD.

The app is a free download from the Google Play™ App store for Android™ mobile devices or from the App store for Apple mobile devices.

The images in this section show the Android app screens. Apple app screens will have a slightly different appearance.

First use

Before using the app for the first time, switch on your Cyrus ONE HD and ensure that **Bluetooth** communication is enabled on your mobile device.

- Launch the app and this screen will appear.

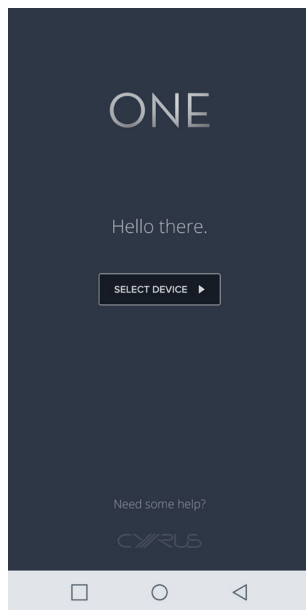

- Touch 'Select Device' to continue.

You should now see the connection ID of your Cyrus ONE HD amplifier in the format ONEHDXX where XX is the last two digits of its serial number.

If there is more than one Cyrus ONE amplifier in range, they will all be listed.

- Touch an ID to connect to it.

If the app connects successfully, the home screen with remote commands will appear.

Using the app

Once the app is installed, volume and source selection will be duplicated on the device screen with some additional functions available only from the app screen.

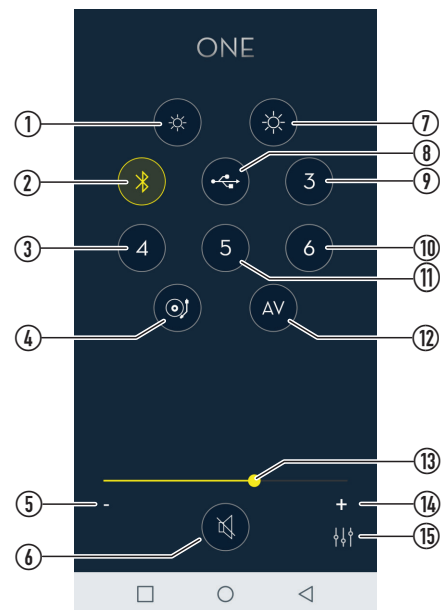

1. Reduce brightness
2. Select **Bluetooth** source
3. Select source 4
4. Select turntable source
5. Step volume down
6. Mute
7. Increase brightness
8. Select USB
9. Select source 3
10. Select source 6
11. Select source 5
12. Select AV source
13. Volume bar
14. Step volume up
15. Settings

Volume control

- Slide the volume bar to the right or left to increase or decrease the volume level.

Source select

- Touch one of the source selection icons to change the selected source.

Mute

Mute will temporarily mute all sound from the speakers.

- Touch the  icon to mute the sound. Touch again to return to the volume previously set.

Indicator brightness

- Touch the  or  icon to increase or decrease the brightness of the front panel indicators.

ONE REMOTE APP

Opening the settings screen

- Touch  to go to the settings screen.

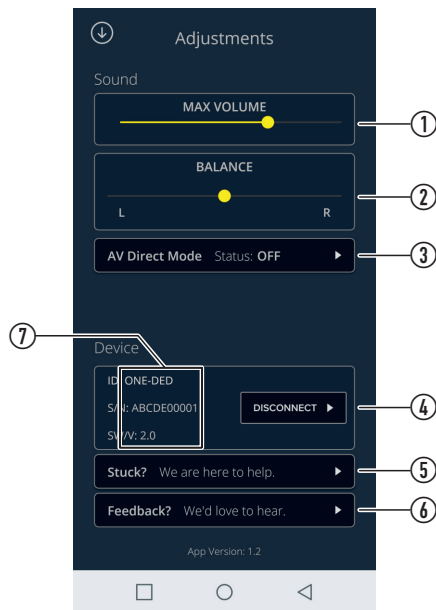

1. Volume limiter slider
2. Balance slider
3. AV Direct mode selection
4. Disconnect tab
5. Help tab
6. Feedback tab
7. Device information pane

Volume limiter

- In the Sound pane you can set the MAX VOLUME slider to set a maximum selectable volume for the app.
NOTE: This does not set a maximum selectable volume for the front panel volume control.

Channel balance

The balance setting will make one speaker louder than the other. Use the balance settings to equalise the speaker volumes if you sit closer to one speaker than the other.

- Move the BALANCE slider to the left or right to change the channel balance.

The balance setting will also be shown on the front panel by the volume control indicators.

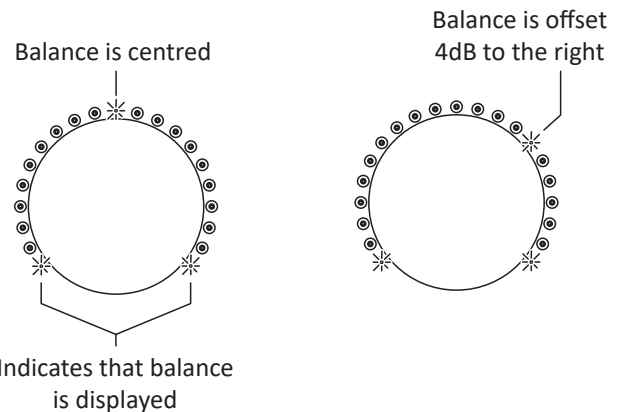

Balance can be moved by up to 9dB in each direction. When turned beyond 9dB to the left or right, only the selected channel will play.

AV Direct mode

Refer to the 'Advanced operation' section on the next page for more information about using AV Direct mode.

Device pane

- The Device pane shows the ID of the connected Cyrus ONE HD and enables you to disconnect the app from your Cyrus ONE HD.

App help screen

- Touch the 'Stuck?' pane to open a help screen if you are having any problems running your app.

Feedback

- Touch the Feedback? pane to tell us about your experiences with the ONE Remote app.

Using the app and playing music simultaneously

It is possible to use the app to control a Cyrus ONE HD from the same mobile device that is streaming music to the **Bluetooth** input.

In this case the ONE Remote app and music stream are separately connected to the Cyrus ONE HD.

NOTE: Connecting the app to a Cyrus ONE HD does not pair your mobile device to the Cyrus ONE HD for **Bluetooth** audio. Follow the instructions in the 'Playing **Bluetooth** devices' section on page 8 to pair your mobile to the Cyrus ONE HD for audio.

ADVANCED OPERATION

AV Direct mode

When AV Direct mode is set, the Cyrus ONE HD switches to work as a power amp when the AV source is selected. This means you can use Cyrus ONE HD as a high quality front channel drive for a Home Cinema system.

CAUTION: Setting AV Direct mode will fix the volume control at a high level whenever the AV source is selected. Use this setting only when the AV input is connected to the front channels of an AV Home Cinema decoder, or with other sources that include a volume control.

Setting AV Direct mode

The setting is changed from the ONE app.

- Switch on the power.
- Touch AV Direct ► on the settings screen.

The AV source indicator will flash and the volume indicators will show if AV Direct is set.

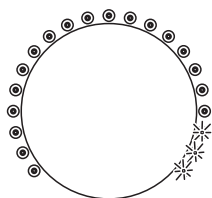

AV Direct mode is set

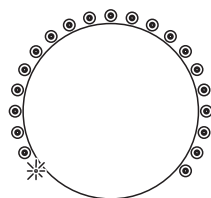

AV Direct mode is not set

- Follow the prompts on the app screen if you want to set or cancel AV Direct mode.

If no changes are made to the AV direct setting, the AV source light will stop flashing to indicate that normal operation has resumed.

Connecting to a Home Cinema decoder

Connect the front left and right channels of the Home Cinema decoder to the AV sockets on the Cyrus ONE HD.

In Use

Select AV when playing a movie and a fixed volume setting will be applied. The front channel sound will play through the Cyrus ONE HD.

Volume operation will return to normal when another input is selected.

Factory reset

Factory reset will clear all settings including -

- Last used volume and source settings.
- Stored balance setting (restored to central setting).
- **Bluetooth** pairing list.
- AV Direct mode setting (when set).

Resetting the Cyrus ONE HD

Factory reset can only be selected from the front panel within 10 seconds of switching on the Cyrus ONE HD.

- Switch on the power.
- Within 10 seconds, turn the volume control anti-clockwise six times.

All front panel indicators will flash twice to confirm settings have been reset.

TROUBLESHOOTING GUIDE

If your amplifier is not operating properly, disconnect the power and check carefully all connections.

If you are in any doubt, consult your retailer.

No sound	
Mute is on.	Deselect Mute
The source is not working (e.g. CD not playing or paused).	Check the source.
No sound from one loudspeaker	
BAL control at extreme limit.	Centralise Balance.
Does your speaker have fuses?	Check speaker, replace fuses.
Speaker cables / interconnects faulty.	Check connections, cables - replace if needed.
Low volume when playing vinyl	
The pickup cartridge may be the wrong type.	Check that the pickup cartridge is a Moving Magnet type (not Moving Coil).
Hum when playing vinyl	
There may be a turntable grounding problem.	Check that the turntable ground wire is securely connected to the grounding terminal on the back panel. Check that the pickup cartridge is correctly connected.
Spurious noises from speakers	
Interconnects or connections faulty.	Check, replace where necessary.
Low level noise from the left speaker shortly after switching on power.	A low level noise may be heard from the left speaker just after power is switched on. This is the Speaker Impedance Detection (S.I.D.) system operating and is normal.
A Bluetooth source fails to pair	
Bluetooth connectivity may not be enabled at the source.	Check that Bluetooth connectivity is enabled at the source. If the problem persists, switch off the power and switch back on, then re-try pairing.
No sound, digital audio source	
No sound from a cable or optical digital source.	Check that the source is connected correctly and set to play. Check that the correct input is selected. Check that the digital sample rate is compatible with the Cyrus ONE HD.
No sound, USB audio source	
No sound from a USB source.	Check the computer audio settings. The audio must be set to output sound to the Cyrus ONE HD device.

No sound, DSD audio playback

No sound when playing DSD files.	Ensure that a DSD player app is installed and correctly configured on the computer. Check that the DSD file type is compatible with the Cyrus ONE HD.
----------------------------------	--

Diagnostic system

Your amplifier has a unique diagnostic system to help you to diagnose problems. There are five error messages that may be displayed – PSU, Output, Over-temperature and System.

These are displayed by light patterns on the source indicators. When an error is detected all the source indicators will light except one that flashes to indicate the type of error.

The drawing shows the flashing indicator.

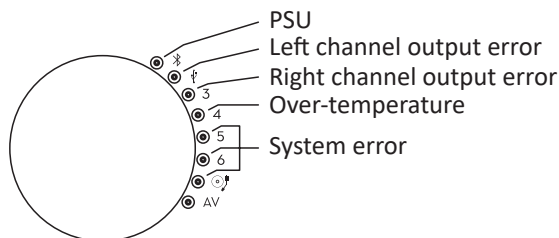

PSU error	
This error will be displayed if the internal power supply is out of range.	This may be a temporary condition when playing excessive levels of deep bass or could be a fault condition in the power supply. The amplifier will mute when the error is detected. If the error clears the amplifier will continue to play normally. If the error remains, the amplifier should be returned to your retailer.
Output error	
The amplifier output has been overloaded or may have overheated. This is usually due to the volume being set too high for prolonged listening or inadequate ventilation for the amplifier. It could also be due to a short-circuit at the loudspeaker terminals.	The amplifier will mute until it has cooled down. If this happens regularly, try improving the ventilation around the case. If the problem continues, then the impedance of your speakers may be too low. If this error remains, switch off the amplifier and check that there are no short circuits at either end of the speaker wiring.
Over-temperature error	
The amplifier has over-heated internally.	Check that the ventilation slots on the amplifier are not obstructed.
System error	
There is an internal circuit error.	Return the amplifier for service.

If a fault condition still remains, return the amplifier to your Cyrus appointed retailer or an authorised Service Centre.

SPECIFICATIONS**Power Supply**

Voltage As plate on rear of unit

Power Consumption

Maximum 750W

Safety Compliance..... CE

EMC (230V)..... CE

EMC (115V)..... FCC

Enclosure

Dimensions (WxHxD).....220 x 86.5 x 390 mm

Weight 5.72kg

Material Non-ferrous chassis

Analogue audio performance

Input Sensitivity (50W/8Ω).....Line..... 200mV

Input ImpedanceLine..... 47kΩ

Frequency Response (-3dB).....Line..... 6Hz > 50kHz

Signal to Noise Ratio (A-WTD).....Line..... 96dBA

Power Output (2 channels driven) .6Ω..... >110W

THD+N (1kHz, 1/3 power)6Ω..... <0.01%
(both channels driven)

THD+N Pre-out (1kHz, 600mV).....Line..... <0.002%

Cable and optical digital audio

Cable input voltage.....500mV pk-pk

Cable input impedance 75Ω

Optical connection Toslink

Sample rate range 32k - 192k

Digital audio formats.....PCM stereo only

USB digital audio

USB formats..... asynchronous digital audio

USB sample rates..... 32k - 192k

DSD (via USB)..... DSD64

Digital audio performance at Pre-out

S/N ratio (Pre-out, 0dB FS, 600mV out)..... >110dBA

THD+N (Pre-out, 0dB FS, 600mV out)..... <0.002%

Bluetooth specification**Bluetooth** version.....V4.1

aptX™, aptX HD™supported for compatible sources

Cyrus reserves the right to change all specifications without notice. E &OE

WARRANTY

The warranty period is two years. No retailer or distributor may vary the terms of this warranty, which is personal to the original purchaser and is not transferable.

Please retain the sales receipt as proof of purchase.

Warranty claims must wherever possible be made through the retailer from whom the equipment was purchased.

This warranty excludes:

- Damage caused through neglect, accident, misuse, wear and tear, or through incorrect installation, adjustment or repair by unauthorised personnel. Any unauthorised servicing will result in loss of warranty.
- Liability for damage or loss occurring in transit to or from the purchaser.
- Consequential damage, loss or injury, arising from or in conjunction with this equipment.

Equipment for attention under warranty should be consigned return carriage paid. If returned equipment is found to comply with the published specification, CYRUS reserves the right to raise a charge.

The above conditions do not affect your statutory rights as a consumer.

**WEEE**

This logo means that this product is not to be disposed of with your household waste. This product should be handed over to a designated collection point to be recycled. Your cooperation in the correct disposal of this product will contribute to the effective usage of natural resources. For more information on collection points, contact your disposal service or City Hall.





Cyrus Audio Ltd., Ermine Business Park, Huntingdon, PE29 6XY, U.K.