

CYRUS





Fig 1

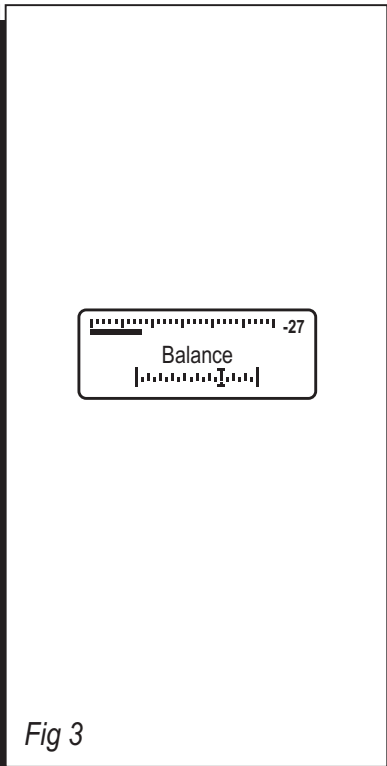

Fig 3

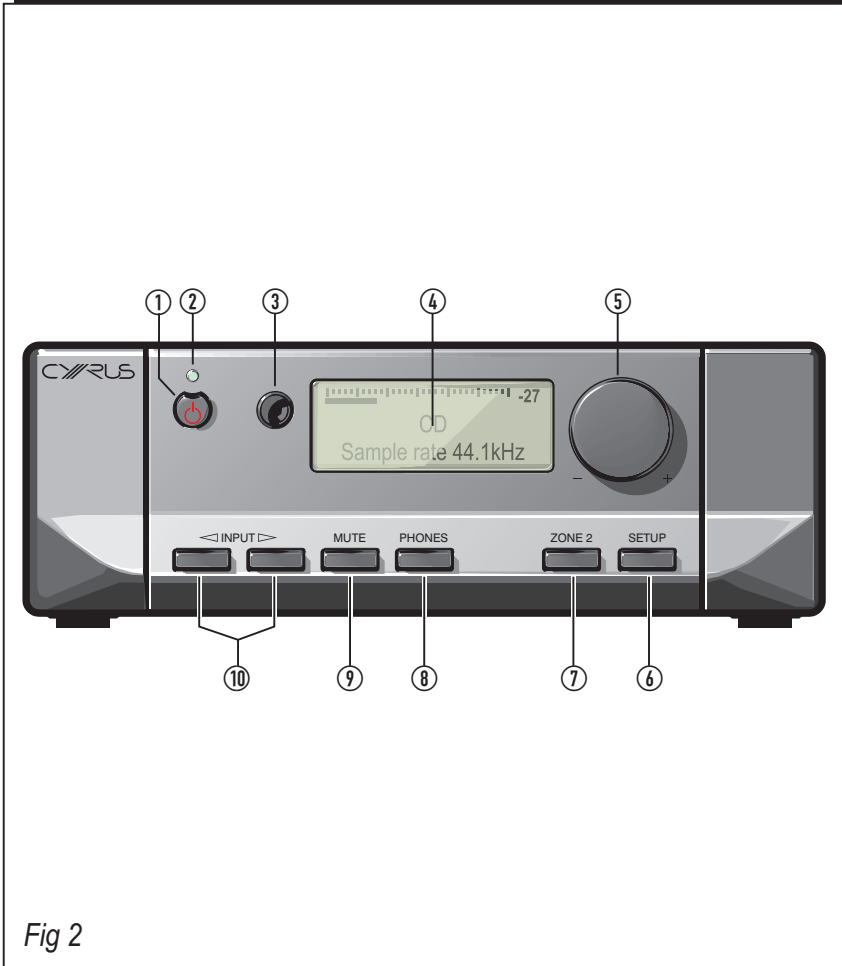

Fig 2

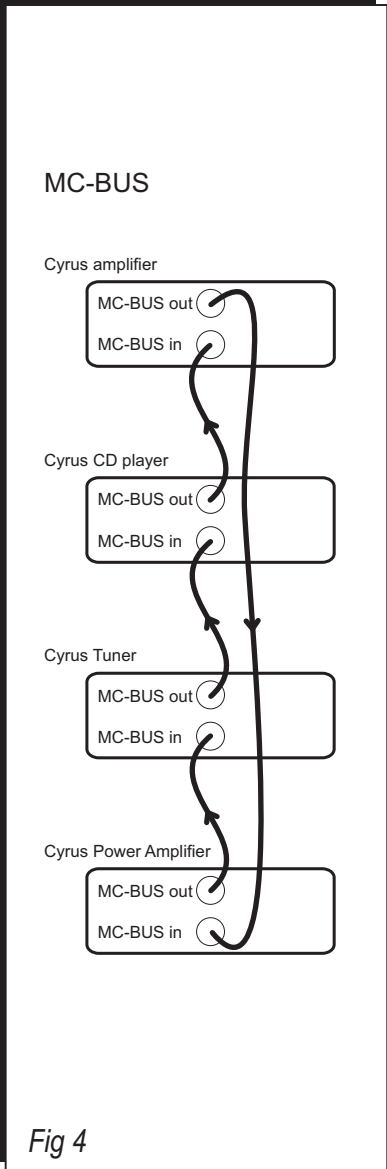
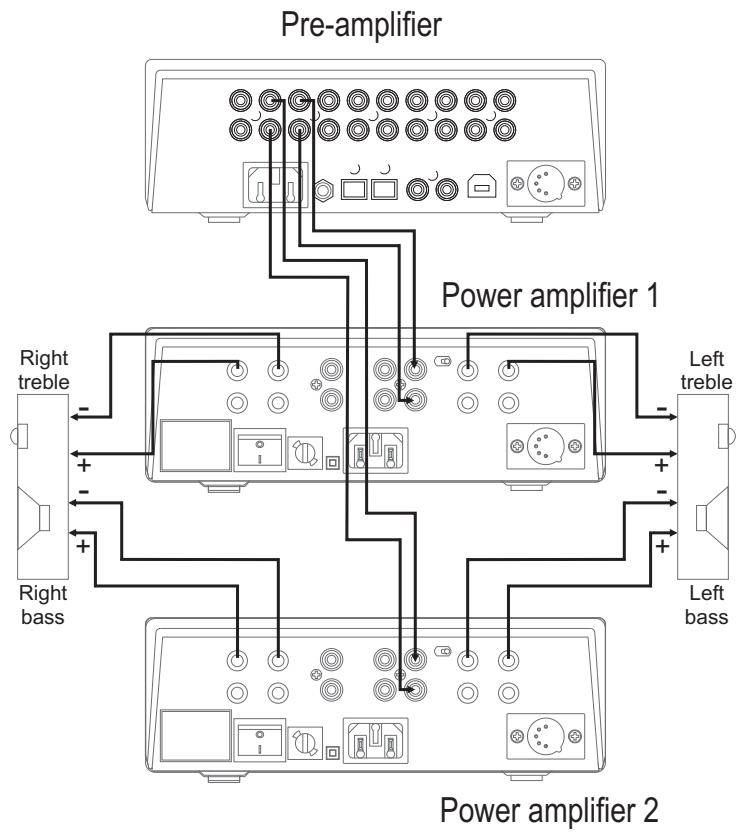

Fig 4



Connecting a bi-amplified speaker system to a pre-amplifier

Fig 5

IMPORTANT! Read before operating this equipment!

CAUTION: The exclamation mark is to draw your attention to important instructions and safety procedures in this manual.



ATTENTION: The lightning flash warns you of the risk of electrical shock presented by components inside this product. Unauthorised personnel must not open this unit.



WARNING: To reduce the risk of electrical shock do not remove any unit covers or panels. There are no user serviceable parts in this product.

WARNING: To reduce the risk of electric shock, do not expose this equipment to rain or moisture.

HEED WARNINGS: All warnings on the product and in the operating instructions should be adhered to.

READ ALL THE INSTRUCTIONS: All the safety and operating instructions should be read before the product is operated.

RETAIN INSTRUCTIONS: The safety and operating instructions should be retained for future reference.

FOLLOW INSTRUCTIONS: All operating and use instructions should be followed.

CLEANING: Unplug this product from the mains before cleaning. Do not use liquid or aerosol cleaners. Use a damp cloth for cleaning.

WATER AND MOISTURE: Do not use this product near water - for example, near a bath tub, wash bowl, kitchen sink, or laundry tub, in a wet basement; or near a swimming pool and the like. The product must not be exposed to dripping or splashing and no objects filled with liquids, such as vases, shall be placed on the product.

HEAT: The product should be situated away from heat sources such as radiators, stoves, or any other products (including amplifiers) that produce heat.

VENTILATION: Slots and openings in the cabinet are provided for ventilation, to ensure reliable operation of the product and to protect it from overheating and these openings must not be blocked or covered. The openings should never be blocked by placing the product on a bed, sofa, rug or similar surface. This product should not be placed in a built-in installation such as a bookcase or rack unless proper ventilation is provided or the manufacturer's instructions have been adhered to.

OBJECT OR LIQUID ENTRY: Never push objects of any kind into this product through openings as they may touch dangerous voltage points or short-out parts that could result in a fire or electric shock.

ACCESSORIES: Do not place this product on an unstable cart, stand, tripod, bracket, or table. The product may fall, causing serious injury to a child or adult, and serious damage to the product. Use only with a cart, stand, tripod, bracket or table recommended by the manufacturer, or sold with the product. Any mounting of the product should follow the manufacturer's instructions, and should use a mounting accessory recommended by the manufacturer.

ATTACHMENTS: Do not use attachments not recommended by the product manufacturer as they may cause hazards.

MOVING THE PRODUCT: A product and cart combination should be moved with care. Sudden stops, excessive force, and uneven surfaces may cause the product and cart to overturn.



POWER SOURCES: This product should be operated only from the type of power source indicated on the marking label. If you are not sure of the type of power supply to your home, consult your product dealer or local power company. For products intended to operate from battery power, or other sources, refer to the operating instructions.

OVERLOADING: Never overload wall outlets, extension cords, or integral convenience receptacles. This can result in an increased risk of fire or electric shock.

POWER CORD PROTECTION: Power supply cords should be routed so that they are not likely to be walked on or pinched by items placed upon or against them, paying particular attention to cords at plugs, convenience receptacles, and the point where they exit from the product.

NAKED FLAMES: No naked flame sources, such as candles, must be placed on this product. Batteries (battery pack or batteries installed) shall not be exposed to excessive heat such as sunshine, fire or the like.

LIGHTNING: For added protection for this product during a lightning storm, or when it is left unattended or unused for long periods of time, unplug it from the wall outlet and disconnect the antenna or cable system. This will prevent damage to the product due to lightning and power-line surges.

CAUTION! POLARISED CONNECTOR (CANADA and USA):

To prevent electrical shock, match wide blade of plug to wide slot, fully insert.

Do not alter or remove this plug if it does not fit your mains power socket. Have a suitable socket installed by a competent electrician.

POWER SUPPLY: (Refer to Fig.1)

Connect the moulded IEC connector of the AC cord supplied plugs into the power inlet  on the rear of the unit.

The mains supply requirement of your amplifier is marked on a label on the rear panel. Before connecting, check that this voltage is the same as your mains supply.

230V Products:	Voltage Range	220V-240V
115V Products:	Voltage Range	110V-120V

If you move to an area with a different mains voltage, contact your local *Cyrus* distributor to have your product converted.

There are no user replaceable fuses in this unit.

SERVICING:

Do not attempt to service this product yourself as opening or removing covers may expose you to dangerous voltage or other hazards. Refer all servicing to qualified service personnel.

CONDITIONS REQUIRING SERVICE: Unplug this product from the wall outlet and refer servicing to qualified service personnel when:

- When the power supply cord or plug is damaged.
- If liquid has been spilled, or objects have fallen into the product.
- If the product has been exposed to rain or water.
- If the product has been dropped or damaged in any way.
- If the product does not operate normally by following the operating instructions. (Adjust only those controls that are covered by the operating instructions. Improper adjustment of other controls may result in damage requiring extensive work by a qualified technician to restore the product to its normal operation).
- When the product exhibits a distinct change in performance.

REPLACEMENT PARTS: When replacement parts are required, be sure the service technician has used replacements specified by the manufacturer or have the same characteristics as the original part. Unauthorised substitutions may result in fire, electric shock, or other hazards.

SAFETY CHECK: Upon completion of any service or repairs to this product, ask the service technician to perform safety checks to determine that the product is in proper operating condition.

PRODUCT SERVICE CENTRES

For product service or technical advice, contact only authorised *Cyrus* service centres. Contact details for *Cyrus* distributors may be found on the *Cyrus* website at www.cyrusaudio.com.

Welcome to the world of *Cyrus!*

Congratulations on your choice of *Cyrus* Hi-fi products. Our state-of-the-art design technology and outstanding quality of manufacture has won countless awards around the world. We are confident that you will derive great pleasure from owning a product from one of the most recognised and respected manufacturers of hi-fi equipment.

Now is a good time to register your new *Cyrus* product. Registration takes only a few minutes, brings the added benefit of a full two year factory warranty and adds you to our mailing list for future product updates and upgrades. To register, visit www.cyrusaudio.com and click the 'Login/Register' link.

Please read these instructions carefully before commencing installation. They provide full guidance to help you install your amplifier safely and correctly.

Preparations for Installation

Before installing your *Cyrus* pre-amplifier check that the following items are included in the accessory box.

- Power Cable
- Remote Handset
- 2 x cables for MC-BUS connection

After removing these items, please retain the packaging.

Install the amplifier in a well ventilated location away from sources of high temperature, dust or humidity. Never stand the amplifier under another unit or on any surface likely to obstruct its cooling or ventilation.

INSTALLATION (Refer to Fig 1):

Key to the rear panel drawings:

1. MC-BUS System Connection	10. Analogue Input 1
2. Pre-Amplifier Output	11. PSX-R Connection
3. Pre-Amplifier Output	12. Digital Input 11 (USB)
4. Zone 2 (& tape) Output	13. Digital Input 10
5. Analogue Input 6	14. Digital Input 9
6. Analogue Input 5	15. Digital Input 8
7. Analogue Input 4	16. Digital Input 7
8. Analogue Input 3	17. Headphone Socket
9. Analogue Input 2	18. Power Inlet

Connecting to the AC Mains Supply

Connect the socket on the AC Power cable to the Power inlet  on the rear panel of the amplifier. Now connect the cable to a suitable AC power point.

NOTE: The means to disconnect this product from the mains supply is the mains plug. Ensure that the mains plug is accessible at all times.

IMPORTANT NOTE – READ BEFORE MAKING ANY AUDIO CONNECTIONS

To avoid possible damage to your amplifier, it is essential to disconnect all system components from the mains supply before connecting or disconnecting audio interconnects.

Connecting Analogue Audio Sources

Analogue Inputs 1-6 are available for the connection of stereo analogue audio sources including -

- Analogue output from CD/DVD Players
- Analogue output from DAB or FM Radio tuners
- Phono pre-amplifier for a turntable
- Televisions
- Analogue Satellite Receivers
- Analogue Tape/Disc recorders
- *Cyrus* surround decoder

The factory set input names for some of the inputs are pre-set as follows -

Input 1 – CD

Input 2 – Tuner

Input 3 – *Cyrus* AV (for a *Cyrus* AV surround processor)

Input 6 – Tape

All inputs may be re-named, but for convenience you may prefer to connect these sources to the pre-named inputs.

Analogue Input 6 is recommended for connection of Tape Recorders. This input is not selectable for recording purposes to avoid howl-round with Tape Recorders, nor is it available to play in a Zone 2 system.

To connect an Analogue Audio source to your amplifier, connect a stereo audio interconnect cable between each component and the sockets as marked on the rear panel. Ensure left and right channels are correctly connected. Make a note of the input number used for each source as the inputs can be re-named at the set-up stage.

Connecting a Turntable

To play a turntable through your unit an external phono pre-amplifier is required. This may then be connected to one of the Analogue inputs.

Digital Audio Inputs

Connecting digital audio sources

The digital audio inputs are compatible with a number of different digital audio sources. These include-

- PC or MAC computer via a USB cable
- Digital Audio output from a CD player
- Digital Radio
- DVD players (for replay of 2 channel PCM programs only)
- Digital Satellite receivers (for replay of 2 channel PCM programs only)
- Digital tape/disc recorders

Using a suitable Toslink optical or Digital phono interconnect, connect each digital audio source to one of the inputs 7-10. Make a note of the input number used for each source as the inputs can be re-named at the set-up stage.

Connecting USB audio sources

The USB audio input 11 may be used to connect the audio feed from a computer. Using a suitable USB cable, connect the USB output from the computer to the USB input ⑩.

NOTE: The USB Audio input is configured for USB slave operation and is not suitable for connection of USB drives or other flash media.

The Qx Digital Input Upgrade

The Cyrus Qx high-end DAC module may also be fitted internally to significantly improve the sound quality performance of digital sources connected to your system.

Amplifiers with a Qx module fitted will have a Qx badge on the front fascia and a Qx logo will be displayed briefly after the product name, when switching on.

If your amplifier has the Qx upgrade fitted, digital input connections are made in exactly the same way as described above.

Connecting a Power Amplifier/Speakers

The *Cyrus Pre XPd* requires an external power amplifier to drive the system loudspeakers. To connect the power amplifier, connect a phono interconnect from one set of the dual Pre Out sockets (② or ③) to the Inputs of the power amplifier. Ensure left and right channels are correctly connected. The speakers connect to the power amplifier. The power amplifier handbook will include instructions for connection of the speakers.

Using the Zone 2 output

Your product includes a Zone 2 pre-amp output that can be used by a system in a second room. You can then extend the sound from the sources in your main system to a second zone. To use the Zone 2 output you will need a set of long interconnects and an amplifier with loudspeakers in the second zone that has its own volume control. Typically the second zone system would be the auxiliary input of an MP3 player dock or could even be another integrated amplifier with full size separate loudspeakers.

Setting up Zone 2 with powered speakers

To set up Zone 2, connect the long phono cables to the Zone 2 output ④ and route them to the line inputs of the powered speakers in Zone 2.

Setting up Zone 2 with a second amplifier

To set up Zone 2 with a separate amplifier, connect the long phono cables to the Zone 2 output ④ and route them to one of the line inputs of the amplifier in Zone 2. Connect the Zone 2 speakers to the Zone 2 amplifier.

NOTE: Amplifiers for Zone 2 use *must* include a volume control.

Connecting a Tape/Disc recorder for recording

When not in use for a Zone 2 system, the dual-purpose output Zone 2/Tape may be used to connect a tape recorder for recording purposes. To set up a tape recording loop, connect a phono cable from the 'Input' or 'Record' sockets of the tape deck to the Zone 2 Output ④ sockets.

NOTE: This section assumes that the 'Play' or 'Line Out' sockets of the tape/disc recorder have already been connected to Input 6 for playback purposes.

Bi-amping

The twin pre-amplifier outputs may be used in conjunction with added power amplifier(s) to significantly upgrade your loudspeaker system through Bi-amping. The *Cyrus* range of power amplifiers is recommended for this application.

NOTE: A bi-amp system can only be set up with speakers that have bi-wire connections (separate bass and treble connections).

Connecting power amplifiers:

Two power amplifiers will be required to partner a *Cyrus Pre XPd* pre-amplifier in a bi-amplified system.

Both stereo and high power monobloc *Cyrus* power amplifiers are available to partner your amplifier.

NOTE:- Refer to Fig. 5 for the wiring plans of a bi-amplified system. Take care to connect each of the amplifier output channels to the correct power amplifier and loudspeaker.

Connecting Headphones

The headphones socket ⑪ is a standard 3.5mm stereo jack socket for connection to a pair of headphones. Headphones may be permanently connected to the amplifier and selected when required with the front panel switch.

Connecting a *Cyrus* Surround Sound decoder

If your system includes a *Cyrus* multi-channel surround sound decoder, it may be connected through your stereo amplifier to share the main front speakers of your system.

In this case, connect a stereo phono interconnect from the front channel outputs of the surround decoder to one of the Analogue Inputs of the amplifier. For this system to function correctly both the amplifier and the *Cyrus surround decoder* must be included in an MC-BUS connection loop and the 'Cyrus AV' input name must be set for the input used (see 'MC-BUS' section and 'Input names' in the 'Setup menu' section).

When set up in this way, the amplifier will automatically check for the presence of the decoder when the 'Cyrus AV' input is selected, then lock its volume setting to an appropriate level.

Connecting a Surround Sound decoder (other brand)

If your system includes a multi-channel surround sound decoder (but not a *Cyrus* model), it may be connected through your amplifier to drive the front channel speakers.

In this case, connect a stereo phono interconnect from the front channel outputs of the surround decoder to one of the Analogue Inputs of the amplifier. For this system to function correctly, the 'AV Direct' input name must be set for the input used (see 'Input names' in the 'Setup menu' section).

When set up in this way, the amplifier will automatically lock its volume setting to a fixed level to match the output of the surround decoder.

CAUTION: The 'AV Direct' input name should only be used for surround decoders that include a volume control, as the volume control of your amplifier will be fixed at a very high level.

MC-BUS System (Refer to fig 4)

Connecting the MC-BUS sockets ① in an MC-BUS system provides unified system control. An MC-BUS loop is established by connecting single phono cables from the MC-BUS output of one unit to the MC-BUS input of another in a daisy-chain. Complete the loop by returning the MC-BUS output of the final component to the MC-BUS input of the first.

With MC-BUS connection established you can control the power function of the entire system from the front panel or remote control. Selecting 'CD' from the front panel will switch on the amplifier, the *Cyrus power amplifier* and a *Cyrus* CD player. When the amplifier is set to Standby, the entire system will also switch off.

When a *Cyrus* Surround Processor is included in the MC-BUS loop, setting of the volume calibration level will take place automatically when the 'Cyrus AV' input is selected. Refer to the handbook for the Surround Processor for further details.

External Power Supply - *PSX-R*



The *PSX-R* is a unique DC power supply which will upgrade the sonic performance of your amplifier. When an amplifier / *PSX-R* combination is installed, analogue and signal related sections of the amplifier are powered from this clean, stable power source while other requirements are supplied internally. This ensures complete isolation of control circuits and sensitive analogue sections reducing AC mains-borne noise and power supply ripple.

To connect the *PSX-R* to the amplifier, disconnect both components from the mains, then plug the connector on the umbilical cord of the *PSX-R* into the Multi-Pole socket on the rear of the amplifier (Ⓜ Fig.1). You will need a mains supply for both units.

NOTE: Connection of a *PSX-R* is detected automatically by the amplifier, so no internal adjustments are required.

CONFIGURATION

Through the setup menu you can customise your amplifier to best match your system.

The setup sequence is activated by pressing the front panel set up button . Repeated pressing of the setup button will step down the list through each available setup option until 'Storing settings' is shown on the display. When each setup screen is displayed, changes may be made to the settings by rotating the front panel rotary knob . During the setup sequence, you can move to the next or previous step by pressing the Input up or down buttons.

Note that the setup sequence will exit, saving any changed settings after 5 seconds of inactivity or after the last option 'Trim input 11' has been completed.

The setup menu options are shown here –

- Setup
 - ↳ Name Input 1 → Choose a name for input 1 from the name list
 - ↳ Name Input 2 → Choose a name for input 2 from the name list
 - ↳ Name Input 3 → Choose a name for input 3 from the name list
 - ↳ Name Input 4 → Choose a name for input 4 from the name list
 - ↳ Name Input 5 → Choose a name for input 5 from the name list
 - ↳ Name Input 6 → Choose a name for input 6 from the name list
 - ↳ Name Input 7 → Choose a name for input 7 from the name list
 - ↳ Name Input 8 → Choose a name for input 8 from the name list
 - ↳ Name Input 9 → Choose a name for input 9 from the name list
 - ↳ Name Input 10 → Choose a name for input 10 from the name list
 - ↳ Name Input 11 → Choose a name for input 11 from the name list
 - ↳ Input 11 auto-hide → Choose on or off (default is off)
 - ↳ Display Mode → Select large input, small input or large volume
 - ↳ Trim Input 1 → Set the sensitivity offset for input 1
 - ↳ Trim input 2 → Set the sensitivity offset for input 2
 - ↳ Trim input 3 → Set the sensitivity offset for input 3
 - ↳ Trim input 4 → Set the sensitivity offset for input 4
 - ↳ Trim input 5 → Set the sensitivity offset for input 5
 - ↳ Trim input 6 → Set the sensitivity offset for input 6
 - ↳ Trim input 7 → Set the sensitivity offset for input 7
 - ↳ Trim input 8 → Set the sensitivity offset for input 8
 - ↳ Trim input 9 → Set the sensitivity offset for input 9
 - ↳ Trim input 10 → Set the sensitivity offset for input 10
 - ↳ Trim input 11 → Set the sensitivity offset for input 11
 - ↳ The display will show 'Storing Settings', then exit setup.

Input names

When your amplifier left the factory, the input names are set as shown below

Input 1 – CD	Input 5 – Input 5	Input 9 – Input 9
Input 2 – Tuner	Input 6 – Tape	Input 10 – Input 10
Input 3 – Cyrus AV	Input 7 – Input 7	Input 11 – Input 11
Input 4 – Input 4	Input 8 – Input 8	

The name of *any* input may be changed to a choice from the following list. Each name may be used once -

CD, DAB, Cyrus AV*, Phono, Tape 3-Head, Tape, Satellite, Cable, iPod, MP3, DVD, Blu-ray, CD 1, CD 2, SACD, CD-R, Linkserver, Jukebox, LaserDisc, Tuner, AV Direct*, TV, TV 1, AV, USB, Satellite 1, Cable 1, Video, VCR, PVR, Cassette, DAT, MiniDisc, Games, Games 1, PC, Laptop, Mac, Special, Keyboard, Aux, Stream X.

Before changing the names of the inputs, we recommend making a list of each input number with your preferred name from the choices above before setting the names. Each name may only be used once. When a name is assigned to an input it will be removed from the list for other inputs.

NOTE:- There are two special function input names marked *.

'Cyrus AV' is reserved for the connection of Cyrus surround sound decoders to one of the analogue Inputs 1-6 and should only be used for this purpose.

'AV Direct' is reserved for the connection of non-Cyrus surround decoders to an analogue input. This input name must only be used for this purpose as the volume level will lock to a very high setting (-6dB) when AV Direct is selected.

Choose 'No source' from the list to name inputs which have no source connected to them. When named 'No Source', an input number will not appear in the input selector scroll sequence or in the Zone 2 select sequence.

In addition, the name 'Tape 3-Head' will appear as an extra option in the naming list for Input 6, and the name 'USB' will appear in the list for Input 11.

Input 11 auto-hide

The USB input has a special 'auto-hide' feature. If this feature is switched on, the USB input will only appear in the input selector scroll sequence when a valid source is connected to the USB input. If no source is connected or if the source is switched off, Input 11 will not appear in the sequence.

Display mode

There are three modes of display operation.

The 'small input' setting will show a three line display with the volume reading at the top of the display, the selected input in the display centre and the current sample rate/lock status at the bottom when a digital input is selected.

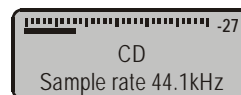

The 'large input' setting will show a two line display with the volume reading at the top and a larger input legend below.



The 'large volume' setting will display large volume characters at the bottom of the screen with the bargraph above.



Input sensitivity offset

It is possible to adjust the relative sensitivity of individual inputs by selecting the appropriate trim option from the menu. This enables the volume level when playing low or high output source components such as tape decks or tuners to be equalized between system sources.



Factory Settings

You can restore the configuration of your amplifier to the factory original settings, changing the input names to those listed above, setting the display mode to 'small input names' and setting all input sensitivity trim settings to 0dB.

To restore the settings, first disconnect the power cord from the amplifier. Hold down the setup key on the front panel and re-connect the power cord.

OPERATION *(Refer to fig 2)*

Key to the front panel drawing:

- | | |
|-----------------------------------|----------------------|
| 1. Standby Switch | 6. Setup select |
| 2. Standby Light | 7. Zone 2 select |
| 3. Remote Eye | 8. Headphones select |
| 4. Display Window | 9. Mute select |
| 5. Level control and setup adjust | 10. Input select |

Power

When power is applied, the STANDBY key ① is used for power control. The Standby light ② shows green when the amplifier is operating and glows red when in standby mode.

In regular use the amplifier should be connected permanently to the mains power supply. When left unattended for a long period (holidays etc) it should be disconnected from the AC supply.

When the amplifier is switched to Standby, all settings for input selection and Volume/Balance are retained.

Selecting an Input

Inputs may be selected from the front panel INPUT SELECT keys ⑩ or with the remote control INPUT SELECT keys. Press the up or down button to scroll up or down through the inputs available.

In addition, the remote control CD key can be used to directly select an input named CD, the TU/DAB key will select inputs named Tuner or DAB and the AV key will select inputs named AV, Cyrus AV, AV Direct or DVD. As a new input is selected the input name/number are displayed briefly.

NOTE: A choice of three styles is available for appearance of the front panel display. These may be selected through the setup menu. The factory default setting - 'small input' display will also identify the sample rate of the selected source (digital inputs only) and indicate 'Invalid Audio Format' for program material which cannot be decoded (such as multi-channel digital sound from DVD players).

Selecting the 'Cyrus AV' or 'AV Direct' Inputs

The 'Cyrus AV' and 'AV Direct' input names are reserved only for use with surround-sound decoders. When one of these inputs is selected, the volume control on the amplifier will lock and the surround decoder input select and volume controls are used to select a multi-channel source and set the volume level for the system.

To unlock the volume control and return to playing a stereo source, select the input you want to play at the amplifier.

NOTE:- The Zone 2 select key will function when 'Cyrus AV' or 'AV Direct' are selected.

Volume and Balance

The level control ⑤ performs the dual functions of volume and balance.

Volume: In normal mode the level control sets the volume in 1dB steps. A bargraph and a numeric scale at the top of the display window show the current volume setting. The last used volume setting is stored when the unit is set to standby.

If the volume is set to an abnormally high volume level (greater than -15dB) before entering standby, the level will be reduced automatically to a safer level of -15dB for next use. Similarly, the volume will be reduced to a safer level if the amplifier was muted while set to a high volume setting, or after listening to headphones at a high volume setting.

Balance: Press the balance control key on the remote control to change the mode of the front panel rotary control ⑥ to set Left/Right Balance. The volume display will change to show a graphic display of the balance setting (Fig. 3). The balance may be adjusted in 1 dB steps by up to 4dB toward the left or right channels by turning the level control or pressing the volume up/down keys on the remote control.

After the 4dB setting, one further step will swing the sound balance completely to the left or right speaker. This setting may be useful when checking if the system channels are working correctly etc.

Mute

Pressing the MUTE Key ④ will mute the volume to minimum level without disturbing the existing volume setting. When muted the display will show that the volume is muted. Press the MUTE key again or move the volume knob up to fade back up to the original volume setting.

Listening to headphones

To listen to headphones, first connect your headphones to the 3.5mm headphone jack on the back panel of the amplifier. Press the PHONES key ⑧. The display will briefly show the legend 'Headphones On', the sound will fade down in the speakers, and fade up in the headphones. To return to speaker operation, press the PHONES key ⑧ again.

NOTE: The PHONES key ⑧ only operates when headphones are connected to the rear panel socket.

Warning: Excessive sound pressure from earphones and headphones can cause hearing loss.

Caution: If you have been listening to headphones at high volume, be sure to turn the level down *before* you switch to normal loudspeaker operation.

Playing music in Zone 2

As supplied from the factory, the Zone 2 system will always play the same source as the main system. Changing the main system source will also change the source playing in Zone 2.

If required, it is also possible to select a different source for Zone 2 from the main system. To select a different source, press the front panel Zone 2 key, the display will show the input source currently selected for Zone 2.



Zone 2 Output
CD

While the Zone 2 indication is showing on the display, turn the rotary control to select a different source for Zone 2. Press the Zone 2 key again to confirm selection of the input source displayed.

NOTE: If a digital input is selected for the main system, then this will be the only digital source selectable for Zone 2. If an analogue source is playing in the main system, then all digital sources will be selectable for Zone 2.

NOTE: Input 6 is reserved for connection to a Tape Recorder, so is not selectable for Zone 2/Recording purposes.

Tape/Disc Playback and Recording

Playback: You can play back a recording by selecting the Analogue Input to which you connected your tape recorder.

Recording: If you have connected the Zone 2/Tape output sockets to the input of your tape recorder, you can make recordings from the input sources connected to your amplifier.

As supplied from the factory, the recording signal will always track the same source as the main system is playing. You can however, select a different source for recording if required. To change the source, press the front panel Zone 2 key to display the input source currently selected for recording.

While the Zone 2 indication is showing on the display, turn the rotary control to select a different source. Press the Zone 2 key again to confirm selection of the input source displayed.

NOTE: Input 6 is recommended for playback connection of a Tape Recorder as it is not selectable for Zone 2/Recording purposes.

OPERATION WITH THE AVRS7.2 REMOTE CONTROL

Your amplifier is supplied with the *Cyrus AVRS7.2* remote control which will also control *Cyrus* CD players, DVD players, tuners and surround sound decoders.

System select keys

Commands may be sent to different *Cyrus* system components by selecting the appropriate system select key on the handset. These keys are marked CD, TU/DAB, AV, AV-S and AV SETUP. The CD, TU/DAB, AV, AV-S keys will flash when any command is transmitted to show which type of product is under control. Commands to a Surround Decoder from the AV SETUP system will flash the AV-S indicator.

- Pressing CD will send commands to a *Cyrus* CD player. This key will also switch on the amplifier and select an input named CD.
- Pressing TU/DAB will send commands to DAB radios or FM Tuners. This key will also switch on a DAB radio or FM Tuner and select an input named Tuner. To change between DAB or FM operation, hold down the TU/DAB key for 3 seconds until the light changes colour. The key will light green when set for DAB commands or red when set for FM tuner commands. NOTE:- The FM band of a DAB radio is not selected in this way, the BAND key is used for this purpose.
- Pressing AV will send commands to a DVD player. This key will also switch on a DVD player and select an input named AV, *Cyrus* AV, AV Direct, or DVD on the amplifier.

The amplifier will respond to the volume, balance, mute and input keys when any of the above systems are selected. In the above examples, direct access input select will only function when these inputs have been named using the amplifier setup menu.

NOTE - The AV-S and AV SETUP keys are not used to control this system.

Multi-channel Surround Sound Systems

The AV-S and SETUP keys of the *AVRS7.2* will control a *Cyrus* surround decoder. If you own a *Cyrus* decoder which was not originally supplied with an *AVRS7.2* remote control, a full copy of the *AVRS7.2* instruction sheet is available on the *Cyrus* website www.cyrusaudio.com.

Full Remote Command Listing

A full listing of the command set available from the *AVRS7.2* is listed in the table on the next page.

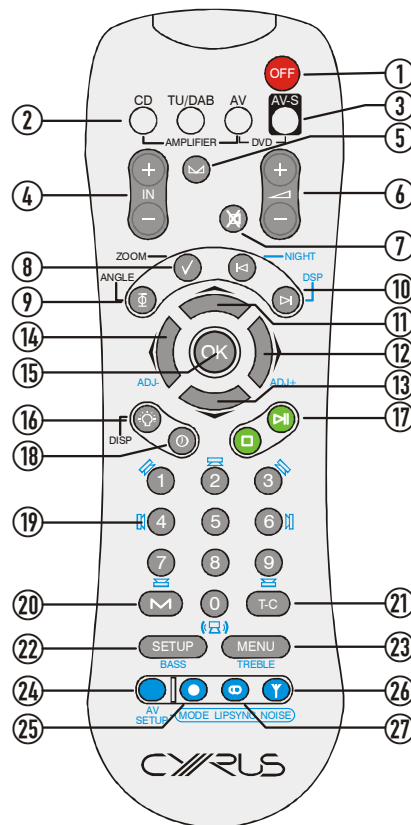

Amplifier, CD, DAB and FM tuner commands

	CD MODE	DAB MODE	TU MODE (FM)
1	Power off all systems		
2	CD, DAB, TU or AV COMMAND MODE SELECT Amplifier, CD, DAB, FM tuner, DVD power on Amplifier input select		
3	AV SURROUND COMMAND MODE SELECT – see table overleaf		
4	Stereo amp/preamp input select		
5	Stereo amp/preamp balance select		
6	Stereo amp/preamp volume control		
7	Stereo amp/preamp mute		
8	-	Select station on display	-
9	Audio phase invert	-	-
10	Next/previous track	Display next/previous station	Next/previous preset
11	Next track	Cursor keys for navigating the on-screen menu options	Next preset
12	Search forward		Scan up
13	Previous track		Previous preset
14	Search reverse		Scan down
15	-	OK key to select menu options	-
16	Display off	Display mode	Display off
17	Play/pause/stop*	Play/pause for replay from memory card	-
18	Display mode	Timer record mode	-
19	Numeric keypad	Numeric keypad	Preset select
20	Memory store	Preset information	Preset store
21	-	-	-
22	-	-	-
23	-	Menu select	-
24	AV SETUP MODE SELECT – see table below		
25	-	Record to memory card	-
26	-	DAB/FM/Memory card band select	-
27	-	Mono/stereo when playing FM	Stereo/mono

*early Cyrus CD players will respond to Play/Stop only

Amplifier, DVD and AV -Surround commands

	AV (DVD & amp) MODE	AV-S (DVD & decoder) MODE	AV-SETUP MODE
1	Power off all systems		
2	CD, DAB, TU or AV COMMAND MODE SELECT Amplifier, CD, DAB, FM tuner, DVD power on Amplifier input select		
3	AV-S COMMAND MODE SELECT DVD and Surround decoder power on		
4	Amplifier input select +/-	Surround decoder input select +/-	
5	Amplifier balance mode	-	
6	Amplifier volume control	Surround decoder volume control	
7	Amplifier mute	Surround decoder mute	
8	DVD Quick access zoom		-
9	DVD Quick access angle		-
10	DVD Next/previous chapter/title		Decoder Night & DSP functions
11	Cursor keys for navigating the DVD on-screen menu options		-
12			Adj +
13			-
14			Adj -
15	OK key to select DVD menu options		-
16	DVD On-screen display		-
17	DVD transport functions		-
18	-		-
19	DVD Chapter/title direct access		Speaker select keys
20	DVD Program store		-
21	DVD Title or Chapter mode		-
22	DVD Player setup		Bass control select
23	DVD Disc menu		Treble control select
24	AV SETUP MODE SELECT Surround decoder power on		
25	-	Mode select	
26	-	Lipsync adjust	
27	-	Decoder noise mode	

TROUBLESHOOTING GUIDE

If your amplifier is not operating properly, disconnect the power and check carefully all connections.

If you are in any doubt, consult your retailer.

No sound	
The amplifier is switched off or in Standby	Bring the unit out of Standby (Standby light - GREEN)
Mute is on	Deselect Mute
The source is not working (e.g. CD not playing or paused)	Check the source
The power amplifier may not be switched on	Check that the power amplifier is switched on
No sound (digital sources)	
The sample rate or sound format of the digital signal from the source may not be correct.	Check that the sample rate from the source is within the specification of the amplifier and that the program is encoded as two channel stereo.
No sound from one loudspeaker	
BAL control at extreme limit	Centralise Balance
Does your speaker have fuses?	Check speaker, replace fuses
Speaker cables / interconnects faulty	Check connections, cables - replace if needed
Spurious noises from speakers	
Interconnects or connections faulty	Check, replace where necessary
Only one digital source is selectable for Zone 2	
If a digital input is selected for the main system, then this will be the only digital source selectable for Zone 2. If an analogue source is playing in the main system, then all digital sources will be selectable for Zone 2.	
Remote control not working	
Remote control not operating	Check batteries
Remote control will not operate a <i>Cyrus</i> CD player or tuner	CD, TU/DAB or AV button must be pressed before sending a command

WARRANTY

The warranty should be registered on-line within 8 days of purchase. No Dealer or Distributor may vary the terms of this warranty, which is personal to the original Purchaser and is not transferable.

Please retain the sales receipt as proof of purchase.

Warranty claims must wherever possible be made through the Dealer from whom the equipment was purchased.

This warranty excludes:

- Damage caused through neglect, accident, misuse, wear and tear, or through incorrect installation, adjustment or repair by unauthorised personnel. Any unauthorised servicing will result in loss of warranty.
- Liability for damage or loss occurring in transit to or from the purchaser.
- Consequential damage, loss or injury, arising from or in conjunction with this equipment.

Equipment for attention under warranty should be consigned return carriage paid. If returned equipment is found to comply with the published specification, *CYRUS* reserves the right to raise a charge.

The above conditions do not affect your statutory rights as a consumer.

WEEE

This logo means that this product is not to be disposed of with your household waste. This product should be handed over to a designated collection point to be recycled. Your cooperation in the correct disposal of this product will contribute to the effective usage of natural resources. For more information on collection points, contact your disposal service or City Hall.

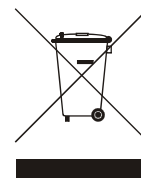

SPECIFICATIONS**Power Supply**

Voltage:As plate on rear of unit

Power Consumption

Standby<1W

Maximum18W

EMC & Safety Compliance CE

Enclosure

Dimensions (WxHxD) 215 x 75 x 365mm

Weight 4.0kg

Material Die cast chassis

Analogue audio performance

Input Sensitivity500mV

Input Impedance 40k Ω

Frequency Response (-3dB) 0.1Hz, >500kHz

Signal to Noise Ratio (unWTD)108dB

Output Voltage1V

Max output voltage3V

Output Impedance120 Ω

THD+N, 1kHz<0.002%

Digital audio performance

Input voltage500mV pk-pk

Input Impedance75 Ω

Sample rate range 32k - 96k

Audio formats PCM stereo only

S/N ratio (Pre-out, 0dB FS) >100dBA

THD+N (Pre-out, 0dB FS)<0.004%

Digital audio performance, Qx module fitted

Input voltage500mV pk-pk

Input Impedance75 Ω

Sample rate range 32k - 96k

Audio formats PCM stereo only

S/N ratio (Pre-out, 0dB FS) >100dBA

THD+N (Pre-out, 0dB FS)<0.002%

Cyrus reserves the right to change all specifications without notice. E &OE

Remote command specification

The remote command specification will be necessary when setting up a programmable handset with a personal computer.

Transmission protocol:..... Philips RC5

RC5 Device address 16 (Amplifier 1)

RC5 command list

16	Volume up
17	Volume down
12	Standby
13	Mute
15	Backlight on/off
24	Source scroll right
25	Source scroll left
40	Balance select
46	Power on
49	Select CD
50	Select Tuner
51	Select AV
62	Power off



Cyrus Audio Ltd., Ermine Business Park, Huntingdon, PE29 6XY, U.K.